

Section 13

Axles and Hardware	31-40
Hubs	15-16
Hub Caps.....	29-30
Rims	13-14
Spokes	11-12

Tires

Avon	5-7
Bridgestone	7
Dunlop	2-4
Kenda	9
Metzeler	7-8
Pirelli.....	4
Shinko	9
Tubes	10
Wheels	17-27
Wheel Weights	9
Wide Tire Kits	26-28

Tires

Dunlop D402 (HD Logo)

They're fitted as Original Equipment to 2000 and later Harley-Davidson® motorcycles, and are approved for use on many models as far back as 1980. Both front and rear sizes feature new computer optimized tread patterns which provide dramatic improvements in wet-road performance. They feature three-ply polyester carcasses that are reinforced with two fiberglass belts. Tube/tubeless construction.

Front		
PCP	Size	Load/Speed
97935	MT90B16 BLK	72H
97936	MT90B16 SWS	72H
97900	MT90B16 WWW	72H
97930	130/70-18 BLK	63H
97939	MH90-21 BLK	54H
Rear		
97943	MU85B16 WWW	77H
97941	MU85B16 BLK	77H
97942	MU85B16 SWS	77H
97937	MT90B16 BLK	74H
97938	MT90B16 SWS	74H
97905	MT90B16 WWW	74H
H rated for speeds up to 210 KPH (130 MPH)		



Dunlop Elite III Tires

Long distance tires with the E3 tread pattern which provides class-leading wet-pavement performance. This tread pattern is not affected by rain grooves, steel bridge decks or tar strips, resulting in a more consistent feel. Features a sport-derived profile that provides a livelier response in turn transitions and a solid feel through turns for confident cornering.

Front			
PCP	Size	Load/Speed	Type
97966	MT90B16	72H	Bias-ply
97968	MM90-19	61H	
97975	90/90-21	54H	Bias-ply
97951	120/70R21	62V	Radial
Rear			
97969	MT90B16	74H	Bias-ply
97970	MU90B16	78H	Bias-ply
97971	MV85B-15	77H	
97967	200/50R18	76H	Radial
97976	240/40R18	79V	Radial
97972	250/40R18	81V	Radial
H rated for speeds up to 210 KPH (130 MPH) V rated for speeds up to 240 KPH (149 MPH)			



Dunlop D402 Touring Elite II Wide Whites

The "Gangster" tire is a touring tire manufactured on the D402 casing. Supplied as front or rear tires. This tire is to be stock on the 1993 H.D. Heritage Softails. Meant for tubeless application but can be mounted with tubes on wire spoke wheels.

Front		
PCP	Size	OEM
97900	MT90B-16 1.5" WW	43118-92
Rear		
97905	MT90B-16 1.75" WW	43119-92



Dunlop D401 Tire with HD Logo

Cruising tire with an advanced tread pattern and compound for improved wet and dry road grip. They are fitted to 1991 and later Harley-Davidson® models. The front tread pattern is specifically designed for even wear and extended mileage. The rear tires feature three nylon plies and two fiberglass belts. Tube/tubeless construction.

Front		
PCP	Size	Load/Speed
97956	100/90-19 BLK	57H
Rear		
97957	130/90B16 BLK	73H
97958	150/80B16 BLK	71H
97952	200/55R17 BLK	78V
H rated for speeds up to 210 KPH (130 MPH) V rated for speeds up to 240 KPH (149 MPH)		



Dunlop K591 V-Rated

The latest technology to meet the demands of today's riders. The matching front and rear directional tread patterns offer better wet grip, cornering and traction for optimum performance, wet or dry. Available in blackwall only with tube/tubeless construction.

Front		
PCP	Size	Load/Speed
97933	100/90-19 BLK	51V
Rear		
97940	130/90B16 BLK	64V
97932	150/80B16 BLK	71V
97934	160/70B17 BLK	73V
V rated for speeds up to 240 KPH (149 MPH)		



Dunlop D404

Tread compound delivers excellent balance of mileage and grip, delivering outstanding water evacuation. Off centre groove gives excellent straight line stability. Bias-ply construction is designed to deliver a smooth ride with excellent load-carrying capacity.

Front		
PCP	Size	Load/Speed
6904	110/90-18 BLK	H
97959	100/90-19 BLK	57H
97960	110/90-19 BLK	62H
97961	80/90-21 BLK	48H
Rear		
97962	130/90-16 BLK	67H
97963	140/90-16 BLK	71H
97964	150/80-16 BLK	71H
97965	120/90-18 BLK	65H
H rated for speeds up to 210 KPH (130 MPH)		



Dunlop Sportmax Q2

New profile tire puts down a bigger footprint at extreme lean angle, higher corner speeds with better grip and handling. Intuitive Response Profile (IRP) technology rear tires provides rider linear steering at all lean angles. Multi-tread technology with a durable center compound and lateral grip compound for better cornering. Jointless band construction utilizes a continuously wound aramid belt to reduce distortion.

Front		
PCP	Size	Load/Speed
97911	120/70ZR-17	58W
Rear		
97912	170/60ZR-17	72W
97913	180/55ZR-17	73W
97914	190/50ZR-17	73W
97915	200/50ZR-17	75W
W rated for speeds of 270+ KPH (168+ MPH)		



Dunlop D205 OEM Replacement

Stock on Screamin' Eagle Fat Boy. Rear tire fits Softail Standard, Softail Custom and Night Train models.

Front		
PCP	Size	Load/Speed
97901	140/75R-17 BLK	67V
Rear		
Use PCP #97980		
V rated for speeds up to 240 KPH (149 MPH)		



Dunlop Qualifier

Ultra high performance port radial tire brings racing technology to the street. Race profile offers quick handling, better grip and footprint when leaned over.

Front		
PCP	Size	Load/Speed
97916	120/70ZR-17	58W
Rear		
97917	180/55ZR-17	73W
97918	190/50ZR-17	73W
W rated for speeds up to 270 KPH (168 MPH)		



Dunlop American Elite Touring Tires

Designed for H-D bikes. Tread design provides even wear and quiet operation in wet and dry conditions. Rear tire features multi-tread technology with long wearing center compound and lateral grip shoulders for enhances cornering.

Front		
PCP	Size	Load/Speed
97977	130/80B17	65H
97979	140/75R17	67V
Rear		
97978	180/65B16	81H
97980	200/55R17	78V
H rated for speeds up to 210 KPH (130 MPH)		
V rated for speeds up to 240 KPH (149 MPH)		



Dunlop Roadsmart

Multi-tread technology with a durable center compound and lateral grip compound for better cornering and even wear. Remarkable wet weather performance, handling and mileage. Micro size carbon particles offer dry grip under acceleration. Qualifier like profile for better cornering and deep, long lateral grooves for greater water evacuation. Blackwall tires.

Front		
PCP	Size	Load/Speed
97906	120/70ZR-17 BLK	58W
Rear		
97907	170/60ZR-17 BLK	72W
97908	180/55ZR-17 BLK	73W
97909	190/50ZR-17 BLK	73W
W rated for speeds of 270+ KPH (168+ MPH)		



Tires

Dunlop GT 501 Sport Bias Tires

GT 501 Sport tires feature bias-ply construction and radial tye tread pattern for a larger footprint and contemporary styling. An optimized profile creates a larger contact patch for increased cornering confidence, with smooth side-to-side transitions. Higher tread-to-void ratio delivers superior grip in dry conditions, with no loss of grip in wet weather. Increased centre tread depth provides improved wear characteristics and enhanced water clearance. Improved rear compound increases wear resistance for longer tread life.

Front		
PCP	Size	Load/Speed
97946	100/90-19 BLK	57V
Rear		
97947	130/90B16 BLK	67V
97948	140/90-16 BLK	71V
97949	150/80B16 BLK	71V
97950	120/90-18 BLK	65V
V rated for speeds of 240 KPH (149 MPH)		



6919



Dunlop F11 Qualifiers

The F11 features a semi-ribbed tread pattern which does an excellent job of channelling water in wet weather riding. The F11 front should be used with the K627 rear for a top-performing street combination. All tires are tube/tubeless construction and are available black or raised white letters.

Front

6921 110/90H (3.75) x 19" Raised white letters

Dunlop Elite III V-Rod Radial Tires

Special version of the Dunlop D207/208ZR designed for V-Rod models. ZR rated blackwall tires to speeds to 149+MPH. 18" rear radial.

Front		
PCP	Size	Load/Speed
97973	120/70R-19 BLK D208	60W
Rear		
97974	180/55R-18 BLK D207ZR	74W
97976	240/40R-18 BLK Elite 3	79V
V rated for speeds of 240 KPH (149 MPH) W rated for speeds up to 270 KPH (168 MPH)		



Pirelli MT66 "Route" Tires (Tubeless)

Great cruising tire provides high mileage without compromising comfort and grip in any weather condition. Features 4-ply nylon construction with deep tread depth. **H-rated tire has raised black lettering** with an aggressive tread design. This is a conventional tire that is tailored for your chopper or cruiser bike.

Front		
PCP	Size	Load/Speed
97881	90/90-19	52HTL
97883	80/90-21	48HTT
Rear		
97885	140/90-16	71HTT
H rated for speeds up to 210 KPH (130 MPH)		



MOTORCYCLE STREET TIRE SIZE CONVERSION CHART

FRONT TIRES

METRIC	ALPHA	INCH
80/90	MH90	2.50/2.75
90/90	MJ90	2.75/3.00
100/90	MM90	3.25/3.50
110/90	MN90	3.75/4.00
120/80		4.25/4.50
120/90	MR90	4.25/4.50
130/90	MT90	5.00/5.10

REAR TIRES

METRIC	ALPHA	INCH
110/90	MP85	4.50/4.75
120/90	MR90	4.50/4.75
130/80		5.00/5.10
130/90	MT90	5.00/5.10
140/80		5.50/6.00
140/90	MU90	5.50/6.00
150/80	MV85	6.00/6.25
150/90	MV85	6.00/6.25

97620



Avon Roadrunner Universal

Designed for use on front and rear wheels, Roadrunner Universal is H-rated to meet the performance demands of machines capable of speeds of up to 130 mph. The low-profile design of the Roadrunner gives a bike excellent stability through corners, and during rapid acceleration and braking. Avon's acclaimed high hysteresis tread compound ensures the best grip in all road and weather conditions. Generous grooves improve water drainage, helping to give Roadrunner Universal its reputation for superb wet road adhesion.

Front or Rear

97621 4.10H 19 Blackwall



Avon "Gangster" Roadrunners

This tire features a classic 2 3/4" wide whitewall. Manufactured with a 4-ply construction. A perfect tire for classics and restorations. The "Gangster" features state of the art dual rubber compound, blending performance and vintage styling. H-rated for speeds of up to 130 MPH (180 KLM/H)

Front and Rear

97645 510-16 (MT90x16) WW



Avon "Safety Mileage " MK 11 Rear

The MK 11 is a full height and profile tire for all Big Twins with 4 full ply construction for rear fitment. S-rated for speeds up to 113 MPH (180 KLM/H) and features continuous centre rib, flanked with interlocking studs, providing excellent traction, safe handling and a smooth ride. This tire is the perfect complement for the Speedmaster Ribbed front tire.

97615 500 S 16 Rear

97616 400 S 18 Rear

97610

97600



Avon Speedmaster Rib Front

Positive steering and excellent lateral stability make the Speedmaster a good choice for front wheel fitment. The Speedmaster is S-rated for speeds up to 113 mph (180 kph). Continuous, siped and interrupted ribs in "cling tread rubber" tread compounded give the Speedmaster very good braking and handling characteristics, particularly wet. The ideal complement is the SM Mk II rear. Tube-type tire

97600 3.25 S x 19" Blackwall

97605 3.50 S x 19" Blackwall

97610 3.00 S x 21" Blackwall

Tires



VBD-Variable Belt Density

Avon's Venom cruising/high load touring tires feature the patented VBD construction to give you unparalleled mileage, consistent handling, outstanding braking and phenomenal grip. With VDB, the Venom's ultra strong Aramid fiber plies are widely spaced on the shoulders and closely spaced around the centre section, giving the best performance at every lean angle.

Avon Venom

Unique sequential pattern produces an exceptionally quiet ride on Venom bias, bias-belted and radial tires. Cooler running, high mileage tire provides outstanding grip and features a multiarc tread contour for light, neutral turn in and cornering stability. Venom tires feature a sidewall snake head logo.

Avon Venom-X Front Tire AM-41

97681	MT90	H	16	Bias belted
97683	MT90	H	16	Bias belted wide whitewall
97661	150/80	H	16	
97653	140/70	VB	18	
97684	100/90	H	19	Bias
97663	110/90	H	19	
97676	120/70	HR	19	Radial for V-rod
97651	120/90	H	19	
97685	80/90	H	21	Bias
97686	MH90	H	21	Bias
97678	90/90	H	21	Bias

Avon Venom-X Belted Rear Tire AM-42

97687	MT90	HB	16	Bias (130/90 H16)
97688	MT90	HB	16	Bias narrow whitewall
97689	MT90	HB	16	Bias wide whitewall
97690	140/90	HB	16	Bias
97691	150/80	HB	16	Bias
97694	150/80	VB	16	Bias belted custom
97692	160/80	HB	16	Bias
97668	150/70	VB	18	Bias



Avon Tires ROADRIDER AM 26 Tires

These tires feature an interrupted centre groove that resists tracking, a large contact patch and a special rubber compound designed to provide excellent grip. Tires feature bias-ply construction and are V-speed rated at 149mph/240kph.

Front	Size	Rating
97626	90/90-19	52V
97627	3.25-19	54V
97628	90/90-21	54V
Rear		
97629	MT90-16	74V
97630	150/80-16	71V



Avon Roadrunner Tires

Avon's Roadrunner tires are designed for both the cruising and touring rider. These are high-mileage, H-rated tires that run cooler, last longer under a heavy load and feature deep high-mileage tread grooves in the central pattern area where tires wear the fastest.

AM 20 Front Tires

97664	130/90H x 16" Blackwall
97650	90/90H (3.00) x 19" BW (fits under stock fender)
97660	90/90H (3.00) x 21" Blackwall

AM 21 Rear Tires

97665	130/90H (5.10) x 16" Blackwall
97666	230/60H x 15" Blackwall



Bridgestone Spitfire S11 Sport Touring Tires

Dual tread construction. Resilient centre rubber compound delivers sport-quality traction when cornering. Tubeless (with tube type rims tubes must be used).

Front

- 97806** 100/90H 19" Blackwall
- 97801** 130/90 16" Blackwall

Rear

- 97810** 130/90H 16" Blackwall
- 97821** 150/80B 16" Blackwall
- 97822** 150/80B 16" Raised white letters

97672



97671



Avon AM23 Bias Belted Rear Tire, Tubeless

These tires are suitable for high performance and custom applications due to Avon's Neutral Stress Contour Design casing technology that permits a huge footprint at all lean angles. Kevlar bias ply control belts maintain stability and resist growth at high speeds. Rated for speeds of up to 280 kph (175mph).

- 97670** 160/80 VB 16

97144



97140
Discontinued

Metzeler ME33 'Laser Front' Tire

Premium sport touring front tire is 'H' rated or 'V' rated to offer durability and performance.

- 97144** 80/90 H21 Tube type
- 97145** 90/90 H21

97153



Metzeler ME99A 'Perfect' Rear Tire

Premium sport touring tire that combines perfectly with ME 33 Laser front tires.

- 97151** 140/90 V16
- 97153** 150/80 VB16



Metzler ME 880 'Marathon' Tires

Specially developed tread design offers high mileage, reliable grip, maximum cornering safety, line stability, linear handling performance and reduced rolling noise. Cruising tires provide reliable brake force from the robust central rib to optimize performance in wet conditions.

Front

97170	130/90	B	16	
97174	130/90	H	16	Wide whitewall
97171	150/80	H	16	
97175	150/80	H	16	Wide whitewall
97172	100/90	H	19	
97176	90/90	H	21	Tube type
97177	120/70	V	21	Tube type

Rear

97180	130/90	HB	16	Reinforced
97192	130/90	B	16	73HTL Wide whitewall
97181	140/90	HB	16	Reinforced
97193	140/90	B	16	77HTL Wide whitewall
97182	150/80	HB	16	
97194	150/80	HB	16	71HTL Wide whitewall
97196	160/70	B	17	Dyna, Deuce 2000-05
97184	200/60	VR	16	
97186	200/50	VR	18	
97187	240/40	VR	18	
97195	280/35	VR	18	

Metzler ME 880 'Marathon' Alpha Sized Tires

Alpha sized tires meet the needs of Harley Davidson dealers and riders: MT90B-16 and MT90-21 front tires; MT90B-16 and MU85B-16 rear tires. All are tubeless.

Front

97165	MT90B-16TL	72H
97168	MH90-21TL	54M

Rear

97188	MT90B-16TL	74M	Reinforced
97197	MU85B-16TL	77H	Reinforced
97198	MU85B-16TL	77M	Wide whitewall
97199	MU85B-16TL	77H	Reinforced NWS

97161



Metzler ME55A 'Metronic' Rear Tire

Superior rear sport touring tire that is a perfect compliment to a ME 33 Laser front tire.

97160	130/90 V16
97161	150/80 VB16

ME 880 Rim Selection Chart

Size	F/R	Rim	Rim Range	Max. Width
130/90H16	F	3.00	2.50-3.50	142
150/80H16	F	3.50	3.00-4.00	161
100/90H19	F	2.50	2.15-2.75	108
110/90H19	F	2.50	2.15-3.00	116
80/90H21 TT	F	1.85	1.60-2.15	80
130/90HB16	R	3.00	2.50-3.50	137
140/90HB16	R	3.50	2.75-3.75	146
150/80HB16	R	3.50	3.00-4.00	153
160/80HR16	R	4.00	3.50-5.00	166
240/50VR16	R	7.50	7.00-8.00	243
240/40VR18	R	8.50	8.00-9.50	243



Shinko 712 & 200 High Value "H" Tire

Rated to carry full loads at speeds up to 130 mph for highway speeds. Large tread blocks resist irregular wear and provide excellent wet weather grip. Tubeless construction, four ply nylon construction with advanced dual crown radius profile offers larger footprint with smooth cornering transitions.

Front

PCP	Size
97864	90/90 H 19 200
97865	100/90 H 19 712
97866	100/90 H 19 200

Rear

97867	130/90 H 16 712
97868	130/90 H 16 200



Shinko 230 Series "V" Tires

The 230 series is capable of carrying high loads for long distances in wet or dry weather. Features belted construction for great handling and ride comfort; the staggered tread works well in the rain and offers a quiet ride.

Front

PCP	Application
97861	100/90 V 19
97863	140/90 V 16

Kenda K-657 Challenger Series

Street tires are 'H' rated for good load capacity, high mileage, and excellent rain dispersion at a low price.

Front

97850	130/90 H16
97851	100/90 H19 TL

Rear

97852	130/90 H16 TL
97853	140/90 H16 TL

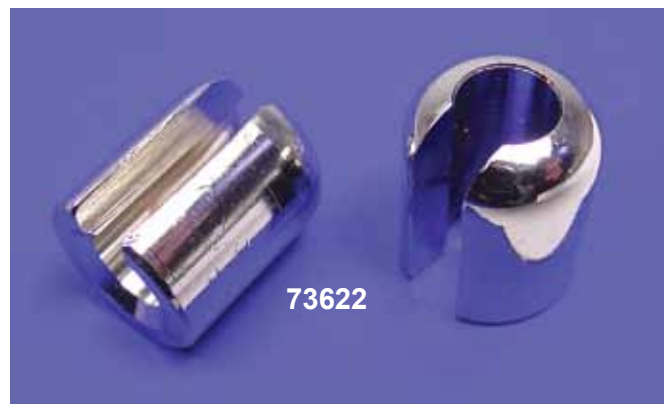

Chrome Wheel Balance Weights

For use with spoke wheels. Sold in 10 packs.

PCP	Oz.
73622	1/2
73645	3/4
73683	1



Mag Wheel Tape-A-Weight

PCP	Oz.	Finish
21722	5g	Chrome, steel (360 pc.)
21723	1/4	Chrome, steel (360 pc.)

Inner Tubes



Metzeler 'Rubber' Tube

Multi-fit, heavy-duty, natural rubber tube resists punctures better than butyl. (TR-4 90 degree steel stems)

97001 130/90-16 to 160/80-16, 15" or 16"



Rim Strips

Heavy, thick, rubber rim strips that offer maximum protection for any size inner tube.

PCP	Size	Stem	Rim	U/M
3519	16"	Side	3"	10 Pack (40575-77)
3527	16"	Center	3"	10 Pack
21760	16"	Side	4"	Pair
21785	17"	Center	4"	10 Pack
3521	18"	Center	3"	10 Pack (40576-77)
21793	18"	Center	5"	10 Pack
21794	18"	Center	6"	10 Pack
3523	19"	Center	2.5"	10 Pack (40577-77)
3525	21"	Center	2.50"/1.85"	10 Pack (40578-80)



Chrome Valve Stem Cover

Chrome cover for inner tube valve stems. Sold as 5 pack.

2452 Rubber valve stem type
2453 Steel valve stem type



Valve Stem Assembly FXSTC 1999-on

16582 43157-83A



TR-15 VALVE STEM



TR-6 VALVE STEM



Heavy Duty Tubes

Inner tubes are available for all types and sizes of tires. Made of butyl rubber for good air retention, carefully molded for uniformity and precision quality to provide for the finest service, long wear.

Inner Tubes

Available in side (SV) or center valve (CV).

PCP	Size	Item	Stem	Type	Valve
3491	16"	5.10-16	Rubber	SV	TR15
3492	16"	5.10-16	Metal	SV	TR6
3490	16"	5.10-16	Metal	CV	TR4
97013	16"	200/60	Metal	CV	
97007	17"	130/80	Metal	CV	
97009	17"	160/70 & 180/60	Metal	CV	
97017	17"	200/55R17	Metal	CV	
97011	18"	180/55	Metal	CV	TR6
97012	18"	240/40	Metal	CV	
3496	18"	3.00/3.50	Metal	CV	TR6
3497	18"	3.75/4.00	Rubber	CV	TR6
3504	19"	275/300			TR6
3505	19"	325/350	Metal	CV	TR6
3506	19"	350/400			TR6
97014	21"	MH80/90 x 2 (3.00)	Metal	CV	
3508	21"	100/90-21 (3.50)	Metal	CV	TR6
97015	21"	120/70-21	Metal	CV	
3507	21"	275/300	Metal	CV	TR6
97016	23"	130/160-23	Metal	CV	



Chrome Plated Brass Valve Stem Caps

Designed to completely cover threads on steel stems. Offered in two lengths with chrome plated brass lock nuts. Each kit has two covers and two nuts.

72194 Medium length
72210 Long length

Spokes

Spoke Sets From Preston Cycle

We are able to offer a full selection of top quality chromed carbon-steel, polished or chromed stainless steel spoke sets. All our spoke sets feature 6/8 guage construction, and our polished stainless steel sets have spokes and nipples made from different types of stainless material to minimize their seizing to each other. We do suggest the use of anti-seize compound on stainless steel spoke sets.

Spoke Buying Guide

We show you the variety of stock and custom rims available from Preston Cycle for custom wheel building. Using our illustrations will help you determine which parts you have and then assist you to the spoke set you need. For example; if you have an aluminum 1978-83 FX model front hub, and you want to lace it with chrome steel spokes to the 21" drop centre rim from an FXWG (OEM 43662-80B or PC# 6277) which is shown in illustration "A", then you would need to use a PC# 925 spoke set. The rim illustration shows the basic rim shape, and the position of the spoke holes in relation to each other.



Diamond and Twirled Spokes

Chrome Diamond PCP	Chrome Twirled PCP	Stainless Twisted PCP	Use
3714	3710	43700	16" DC (F & R) "A" 1936-04
3716	3712	43702	21" DC/steel + alloy FXST, Wide Glide hub "B & E"



Stainless Steel Twisted 16" Steel Spokes

A set of stainless steel spokes for 16" drop center rims. A new style of twist similar to our "Twirled" spokes.
43700 Set of 40 spokes and nipples 1936-04



Spoke Sets

Chrome	Rippled	S.S	Application
	43708*	43706	16" Drop centre, steel spools 1936-04
		43716*	18" "B" rim & 19" "C & D" rim
43713*	-	-	21" Drop centre, XL, FX fr. disc

*Buchanan



6/8 Gauge Nipple Set

Sold in packs of 40 to fit our spoke sets.

- 43096** Chrome standard
- 43097** As above stainless
- 43098** Chrome extended
- 43099** As above stainless

Note: When PC spoke kits are laced to 19" OEM #43001-79 rims PCP 43098 extended chrome spoke nipples must be used as the inside diameter of this rim is larger than others.

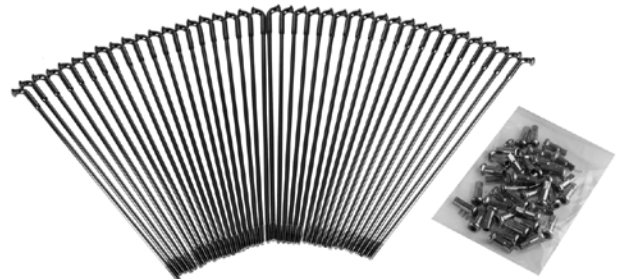

T/L Stock (Zinc) Spoke Sets-USA 1936-04

43715 21" spoke set (43057-80B)

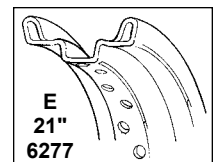
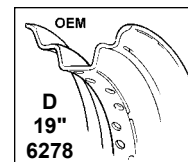
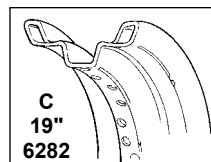
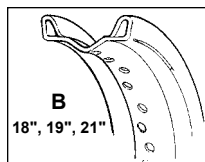
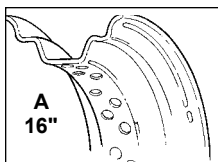
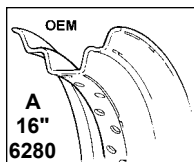

Spokes

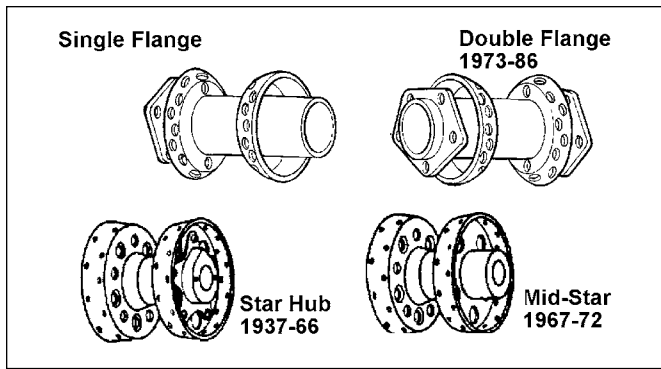

For Use With Spool Hub

Chrome	Stainless	Rim Size"	Illustration Rim Type
916	3604	15	A
924	3605	16	A
919	3606	18	B
924	3607	19	B
924	3606	19	C & D
920	3608	21	B & E

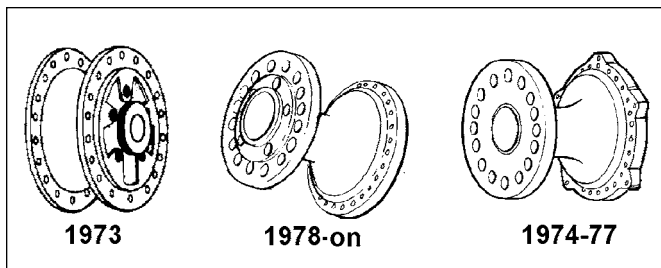

For Use With FX-XL Front Disc Brake Hub

Chrome	Stainless	Rim Size"	Rim Type
929	3609	19	C & D
926	3610	19	B
925	3611	21	B & E

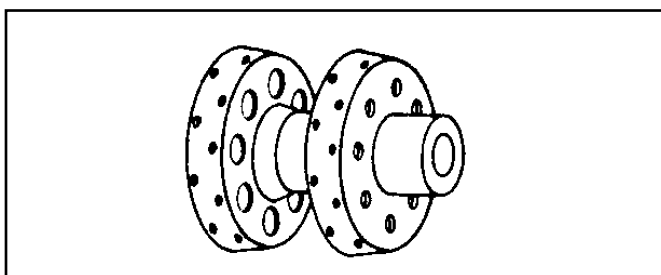

For Use With Sportster Rear Wheel Spool Hub

Chrome	Stainless	Rim Size"	Rim Type
916	3604	15	A
930	3605	16	A
924	3612	18	A
924	3606	18	B



Replacement Spoke Sets

Heavy duty 6-8 wire gauge spoke set for all twins. Available in either chrome plated with chrome nipples or stainless with stainless nipples. Complete sets of 40 spokes and nipples.

NOTE: Use hub illustrations to select proper spoke sets. Note spokes available in chrome or full stainless.

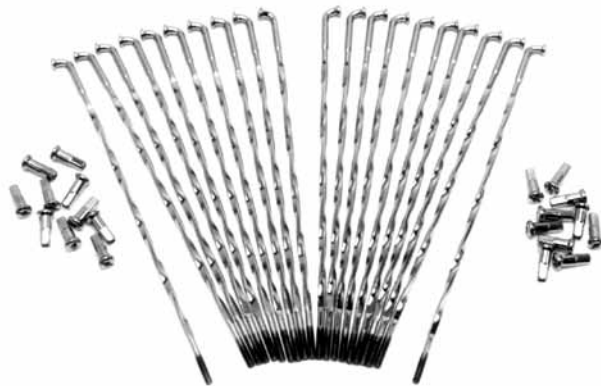

Chromed Steel 16" Twisted Spokes

40 chromed steel spokes and nipples for 16" drop center rims. A new style of twist similar to our "Twirled" spokes.

- 43704 Set for 16" rims 1936-04
- 43705 Set for 21" rims (Steel hubs)



Deluxe Spoke Wrench

Rowe spoke wrench to fit spoke nipples, sized one to six. 5849

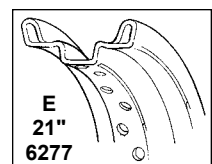
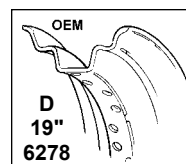
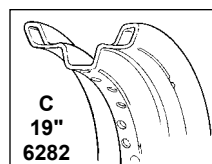
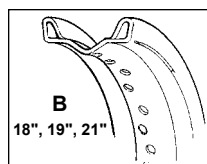
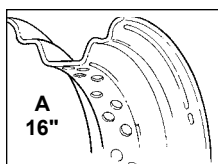
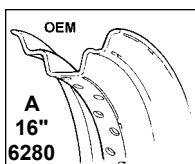



6280

OEM Factory Style Chrome Rims "A"

Original drop centre design with deep indent for safety beads.

PCP	Diameter	Width
6280	16"	3.0 (as OEM w/lrg hole)
70735	16"	As above, black powder coat
70752	16"	3.0 (as OEM w/sm. hole)
70753	16"	4.0 (as above w/large hole)

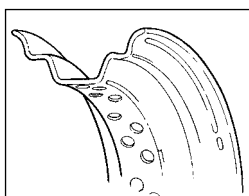
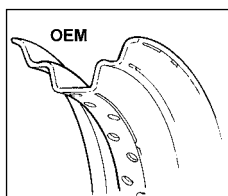

70720

70721

Chrome Steel Wheel Rims

Drop centre style with rolled edges on 19" & 21" with high quality chrome plating. Features OEM style spoke dimple pattern and rim width for easy lacing and truing.

PCP	Size
70720	19" x 2.5" (DC) (43001-79)
70721	21" x 2.15" (43662-80B)



6276

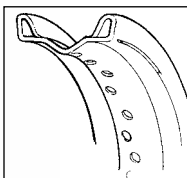

69801

69800
Discontinued

Conventional Chrome Rims "B" style

This type is flat or English style. It will fit front tires only, available in the following sizes.

PCP	Diameter	Width
6276	21 Inches	1.85"

Topline Drop Centre Chrome Rims

Exact replacement, OEM quality and chrome plated.

PCP	Size
69802	16" small side hole 1997-08 (43085-97)
69801	21" FXWG-FXST 1980-08 (43662-80B)

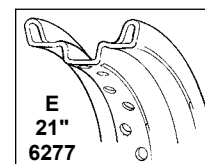
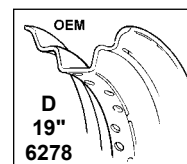
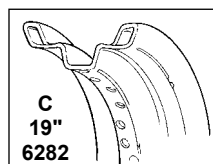
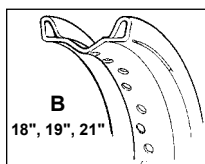
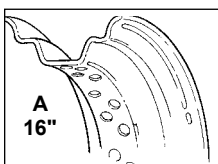
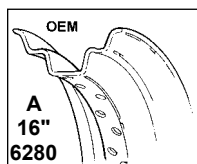

Rims

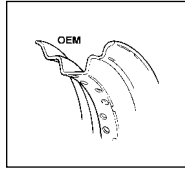

OEM Factory Style Front Chrome Rim "D"

2.50" x 19" drop-centre 40 hole front rim with safety bead.

OEM 43001-79 and 43018-73.

6278 19" Drop centre



T/L Chrome 19" Drop Centre Front Rim "D"

69803 43001-06

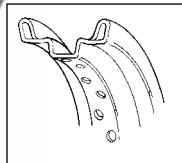

21" Drop Centre Rim "E"

Chrome plated rim with rolled edge as the H-D 21" wheel.
(OEM 43662-80B)

6277



Skull Valve Stem Cover

44081 Pairs



Tubeless Tire Valves

Replacement tubes for mag style tubeless tire rims.

PCP **OEM**

73664 43150-83 (5 pack)

73665 43157-83A (5 pack)

73666 40999-87 (5 pack)

73668 Chrome inner type (each)

73621 Chrome outer type (each)

73669 Chrome angle type (each)



Wheel Hubs

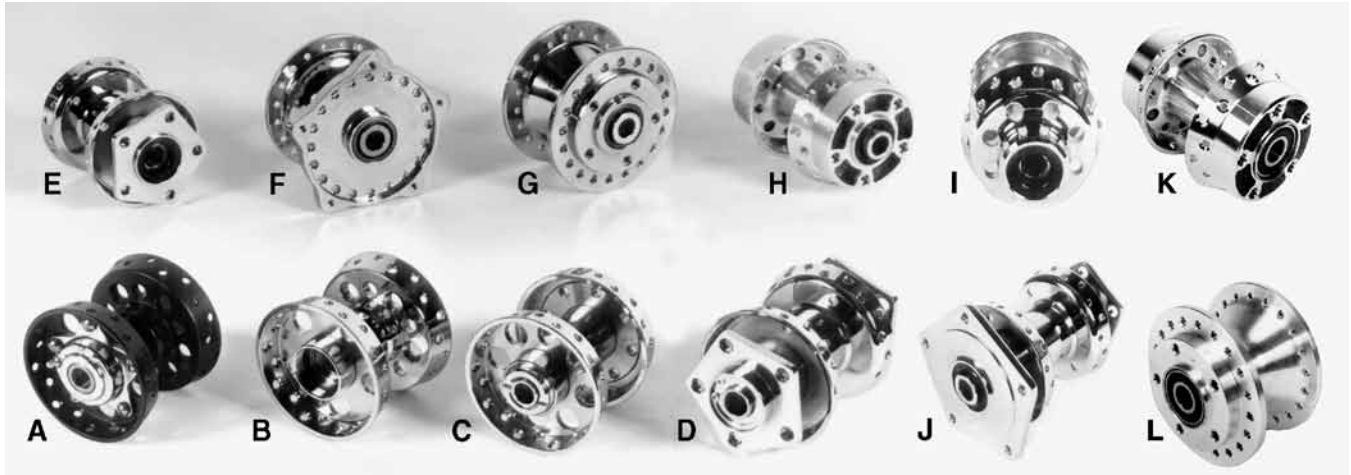

Front Hubs

PCP	Application
5050	(E) 1984-99 FXST, FXSTC, FXDWG, (43672-84)
59837	(I) 1986-99 FXST, FXDWG (43672-84A)
59838	(I) 2000-04 FXDWG, FXST, FXSTS (43672-00)
53004	(E) 1986-99 FLST, FLSTC single disc (43053-86)
5067	(G) 1984-99 FXR, FXD, FXRS 1984-85 FXSE-80, FXEF single disc (43619-84)
59839	(G) As above, dual disc
59843	(L) 2000-04 FXDL, FXDX dual disc 21" (43610-00)
59841	(L) As above, chrome single disc/dual disc
59844	(E) 1988-99 FXSTS, FLSTS (43677-88)
53011	(D) 1987-99 FLT (43404-87A)
59845	(K) 2000-04 FLT (40988-00)
59848	(K) 2005-on XL

Rear Hubs

PCP	Application
59831	(H) Billet 1986-99 FXR, FXRS, FXST, FXSTC, FLST (40976-86A)
53014	(D) Steel 1986-99 FXR/S, FXST/C, FLST (40976-86)
53012	1987-99 FLT (41020-86A)
59832	(K) 2000-on FXST, FXD, 2002 FLT (40976-00)



Chrome Inner Hub Covers

Covers fill area between pulley or rotor mount flange and spoke hole flange on hub for smooth appearance and easy cleaning. Front models fit rotor side, rear kit fits both sides.

PCP	Type	Qty	Application
45494	Front	1	1987-93 FXST
45495	Rear	2	1986-95 FLST-FXST



Rear Hub Rebuild Kits

PCP	Application
43090	FXST 1984-90
43091	FXST, FLST, XL 1992-99
43092	Cast wheels 1992-99
43093	FXST, XL, FXD 2000-07 with 3/4 bearing (9267)



Adjustable Inner Hub Spacer 1973-99

Fits 1973-99 wire wheels and most custom wheel applications.

73633

Hub Parts



Front Wheel Bearing, Race and Seal Kit

Each kit contains two each, bearing, race and proper seals. Three kits available.

PCP	Application
3510	1980-on FXWG laced wheel
3512	1984-94 FXR's cast or wire wheel 1984-99 all FX-FLT-XL models cast or wire wheel 1991-99 Dyna



Front Wheel Hub Service Kit

Each kit contains two each, bearing, race, seal and one seal spacer. Also included for certain applications only are two each snap ring and seal retainer washers. Internal bearing spacer is not included. This may be ordered separately. Check listing. (Does not include hub.)

PCP	Fits	Wheel Type
3514	1984-on FXWG	Wire
3515*	1984-85 FXST	Wire
43087*	1986-99 FXST 1984-99 FXDWG	Wire
43088	1992-99 FLSTF	Cast
43089	1987-91 FLST	Cast

*Does not include snap rings and seal washers.



Late Wheel Seal 1983-99

Replaces OEM #47519-83A. Used on all 1983-99 models with cast or wire wheels. Sold in 10 packs.

14069	.250"
14107	.411"



Rear Wheel Bearing Race and Seal Kit

Kits include two each of, bearings, races and seals. Kit fits 1983-94 FXR, 1983-99 FXST, FLST, FLT, XL and 1991-99 Dyna with cast or wire wheel.

43135



BT Hub Rebuild Kit

Kits include bearings, races, seals, snap rings, seal retainer washers and seal spacers. Hub and internal bearing spacer not included. Fits 1986-94 FXR, 1984-99 FXST, FLST.

43139

Front Wheel

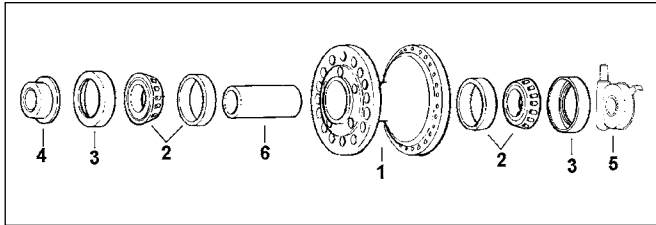

FX & Sportster Front Hub & Parts 1978-on

PCP	Description
1 5067	Chrome single disc hub assembly FXR, RS, XLS-FXS 1984-on (43619-84)
2 15504	Bearing & race FX, XL, 1973-on (9052)
3 14069	.250 Wheel seal FX-XL 83-99 (47519-83A) (10)
79412	James as above (DL) (5 pack)
79411	James .411 wheel seal L85-99 (5 pack)
14107	As above, Preston (10 pack)
5 3722	Speedo drive unit, FXR, FXRT, FXSB, FXE-80, XL, XLS, XLX 1984-on (67127-84A)
2542	Speedo drive unit, FXWG, FXST 1985-on (67120-84B)
4072	Speedo drive unit, FXLR 1987-on (67132-85A)
6 3305	Wheel bearing spacer, violet 2.564" long, FX 1978-on (43623-78)



Late FX-XL Front Wheel

Complete front wheel assembly for all 1983-on FX-XL-FXR's. Laced and trued with all new components. Chrome plated.

6143 19" OEM (drop centre rim)

6144 21" Custom 2.15 rim

The 2.50" OEM rim is the stock factory type 43018-73.



70877

70919



Reverse view of hub

Front Wheels for 1984-99 FXR-FXD

Single disc fits 35mm and 39mm forks.

70876 19" D.C. in diameter and 2.50" width

70877 21" in diameter and 2.15" width



Front Internal Hub Kit FX, FXE, XL, FXR

Includes all internal parts for complete rebuilding of all alloy front hubs. Includes inner spacer, bearings, races, seals and seal spacer. Hub is not included.

PCP	Type	Application
43136	Single	1984-91 FX, FXR, 1984-91 XL
43137*	Single	1992-94 FXR, 1992-99 FXDL
43138	Single/ Dual	2000-on FXD, XL Cast or wire wheel (w/2-3/4 bearing)

*Order spacer shims separately.

XL Front Wheel Assembly 2005-on

Laced and trued wheels feature chrome hub with internal bearings installed, choice of chrome or stainless steel spokes and chrome drop centre rim.

Chrome Spokes	S.S. Spokes	Rim Diam.	Rim Width
70919	70920	19"	2.50"
70921	70922	21"	2.15"



Inner Hub Bearing Tube Spacer

May be used in some cast mag wheel applications, when flange is removed. Check for proper length fit.

16602 Front XL, FXD 2000-on (43613-00)

Wheels

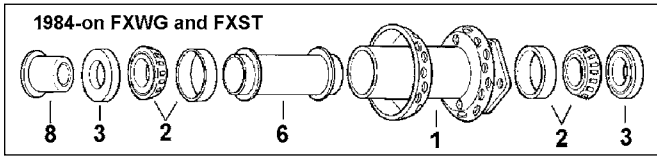

Wheel Hub Parts 1984-on FXST,FXDWG,FXWG

PCP	Description
1 5050	Chrome complete 1984-on 1 Flange (5/16 brake holes) (43672-84)
2 15504	Bearing & race 1973-99 (9052) (1 set)
3 14069	Wheel Seal .250 1983-99 (47519-83A) (10 pack)
79411	As above, James .411 L85-99 (5 pk)
14107	As above, Preston (10 pack)
6 2529	Wheel bearing spacer 1973-on orange 4.420 (43601-73)
2530	Wheel bearing spacer 1973-on yellow 4.434 (43602-73)
2531	Wheel bearing spacer 1973-on white 4.448 (43603-73)
8 2261	Spacer R/S bearing FXST 1984-99 (40910-84A)



FXST & XL & FXR Rear Wheel Assembly

Chromed 16" to fit 1986-99 FXR,FXRS,FXST,FXSTC, & FLST and Sportster 1986-99 Note: FXR applications must use PC# 5063 seal spacers. Hub only is #53014. Wheels are 16" x 3.5" wide.

- 70850 With chrome spokes
- 70851 With stainless spokes



Rear Wheel Spacers

Fits BT 1982-99 models.

- 16580 4.308" spacer for wide hub (43608-82)
- 16581 Spacer washer (43650-82)



Chrome Rear Wheel Spacer Set

Fits 2002-on Touring models that utilize a 1" diameter axle.

- 16610 41163-04

43084



Double Row Retro Wheel Bearing Kit

Double row wheel bearings eliminate wheel play, have a longer wear life, require no adjustment and are prepacked with SR1-2 grease. All kits include two bearings, centre spacer & stainless spacers. Fits models with Timken bearings.

Front Bearing Kits

- | PCP | Application |
|-------|-----------------|
| 43083 | 1995-99 FXD, XL |

Rear Bearing Kits

- 43084 1984-99 FXST, FLST, 1991-99 FXD,XL



70852

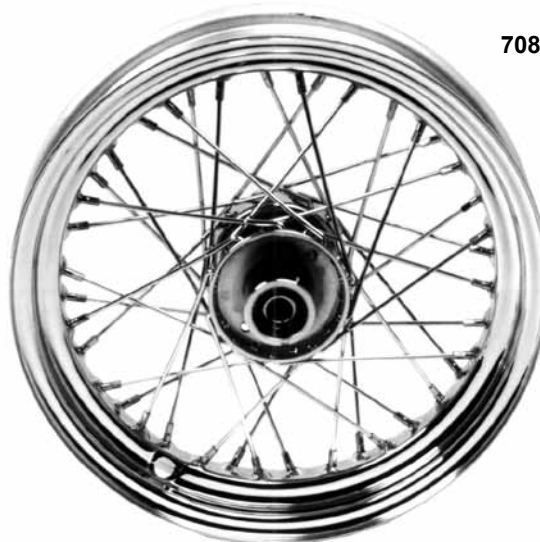

21" Wheel Assemblies

21" wheels give Harleys the late FXST-FXWG look. Available for all years and models, laced and trued, complete with bearings. Ready to install. Rim is 1.85 x 21, not drop centre.

PCP	Years	Models	Type
6144	1984-99	FXE-FXR-XL's	Disc (1)
70865	1984-99	FXST-FXWG	Disc (1) 215 x 21
70866	1984-99	FXWG	Disc (2) 215 x 21



70856



70798

FLT Wheels 1987-99

Chrome 16" front wheel assembly features a drop centre 16" x 3" rim laced with chrome or stainless steel spokes. Complete with bearings, seals and internal components. Fits FLT, FLHT, FLHS, and Road King models 1987-99.

Front Wheels

70796 Chrome spokes (43403-87)

Rear Wheels

70798 Chrome spokes (41010-86)

70799 Stainless steel spokes

Chrome Front Wire Wheel Assemblies

For BT models 1984-on with 41mm forks.

FXSTS 1988-99

16"	21"	
70852	70856	Chrome spokes

FXST, FXDWG 1984-95, FXWG 1984-85

70863	70865	Chrome spokes
-------	-------	---------------

FXST, FXD, FLSTS 1996-99

70867	70869	Chrome spokes
70868		Stainless steel spokes

FLST 1986-99

70872	Chrome spokes
-------	---------------

FLT 1987-99

70796	-	Chrome spokes
-------	---	---------------

Wheels



FXD, FXWG, FLST Rear Wheels (40975-86A)

Wheels feature an updated rear hub with smooth flange area.
Fits 1997-99

Chrome Spokes	Stainless Spokes	Rim Diam.	Rim Width
70783	70784	16"	3.0

Wheels With 40 Chromed Twirled Spokes

These wheels include chrome hubs with internals, chrome rim, and chrome twirled spokes assembled and trued.

- 70842** 16" Rear, 1986-on FXST-XL
- 70843** 21" Front single, 1984-99 FXST
- 70845** 19" x 2.50" Front dual XL-FX 1984-99



Late XL Rear Wheel Assembly

16" type chrome rear wheel assembly for all 1979-on XL's. Laced and trued with new components. Assembly includes all internals.

PCP	OEM	Years
6126	40951-82	1982-85

FLST 1986-99 Wheels with Chrome Spokes

PCP	Size
70854	16" Front wheel
70872	21" Front wheel



Front Wheels for 41mm Forks 2005-on

Chrome Spokes	Stainless Spokes	Rim Diam.	Rim Width	Fitment
70915	70916	16"	3.00"	FLST, FLSTS single disc
70917	70918	16"	3.00"	FLT single disc

FXD, FLST, FXST Rear Wheels 2005-on

Chrome Spokes	Stainless Spokes	Rim Diam.	Rim Width
70924	70925	16"	3.00"

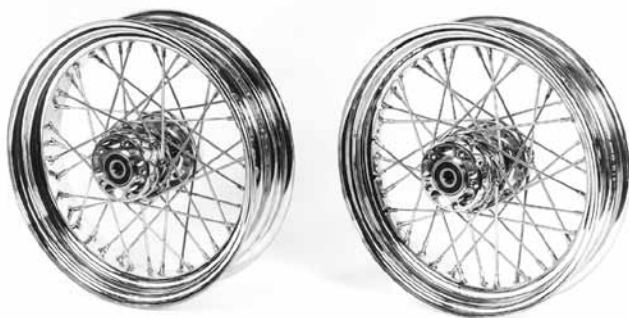

2000-04 Rear Wheel Assemblies

Rear wheels fit FXST, FLST, FXD, FXDWG and XL models. Assemblies feature a chromed alloy hub with sealed bearing and spacer tube installed. Complete wheel is laced and trued with choice of chrome or polished stainless steel spokes and a chrome drop centre rim. Wheel easily installs using existing stock components.

Chrome Spokes	Stainless Spokes	Rim Diameter	Rim Width
70890	70892	16"	3.00"
70891	70893	16"	4.00"

2000-on Front Wheel Assemblies

Wheel assemblies feature a chrome alloy hub with sealed bearings and spacer tube installed. Wheel comes laced and trued with choice of chrome or polished stainless steel spokes and a chrome drop centre rim. Wheel is easily installed using existing stock hardware.

XL 2000-04, FXD with 39mm forks, XL STD Hugger, 1200-FXD, FXDL with 39mm forks and single disc.

Chrome Spokes	Stainless Spokes	Rim Diameter	Rim Width
70882	70884	19"	2.50"
70883	70885	21"	2.15"

XL-FXD 2005-on

70919	70920	19" DC	2.50"
70921	70922	21" DC	2.15"

FXST-FXDWG-FXSTS with 41mm forks and single disc

70886	70887	21"	2.15"
-------	-------	-----	-------

FLST-FLSTS with 41mm forks and single disc

70888	70889	16"	3.00"
-------	-------	-----	-------



19" Wheel Conversion - USA

For customizing flexibility, this kit adapts 19"-21" narrow glide wheels from 1977-02 and spaces it out to fit a 41mm front end. With the custom spacers and the specially designed axle, you can mount any dual disc wheel to any wide glide front end. Kit includes 1" aluminum disc spacers, (as needed), axle, axle spacers and all mounting hardware. Spacers are polished and chrome plated. Axle and steel spacers are cadmium plated.

53501	1984-99 FXWG for single disc
43107	Extra spacer for #53501 to use dual rotors
53502	2000-03 FXWG
43119	Extra spacer for #53502

Wheels



T/L Cast 9 Spoke Wheels

Stock FLT wheels feature blacked out spokes.

PCP Application

70718 Front Touring 2000-06 (43345-00)



T/L Solid Cast Aluminum Chrome 16 " Wheels

Front solid to fit 1987-99 FLST, FLST/C/F, & FLSTN models

70710 41031-95



Chrome Wheel Covers

Contour formed to fit Alloy 16" FXST rear, and Fat Boy front and rear alloy wheels. Covers up to the step at the valve stem hole area. Both are held in place by the rotors and belt pulley.

Sold in Pairs

PCP F/R

45934 Front FLSTF 2000-on

45931 Rear FLSTF-FXST 1987-99





T/L 16" Black Cast Aluminum Rear Disc Wheel

Wheel assemblies fit 2000-02 Softail (except Springer and Deuce), Dyna 2000-05 & 2000-04 XL models.

70733 41029-00



T/L Chrome Slotted 16" Front Wheel 2000-06

Bolt-on wheels fit 2000-06 FLST/C/F/N models.

70728 41022-00



Sealed Wheel Bearings all 2000-on

Lubricated ball type wheel bearings include dual seals on each side. Fits all BT and XL models 2000-on.

15749 3/4" I.D. front and rear all Softail/Dyna 2000-06 & XL 2000-07 models (9267) (each)

15750 1" I.D. front FLT 2000-07 & rear 02-07 (9247) (pair)

15751 25mm I.D. Bearing (9276) (pair)
FXST/B/C-FLST/F/N-FXSTD 2007-on front
FXST/B/C-FLST/C/N 2008-on front & rear
FXCWC 2008-on rear

FLSTFB 2008-on rear

FLSTF 2008-on front & rear

FXD 2008-on front & rear

FLT 2008-on front & rear with out ABS brakes

XL 2008-on front & rear

V-ROD 2008-on front & rear

15754 FLT models 2008-on with ABS brakes (9252) (pair)

15754 25mm Bearing rear FLT 2008-on (9252) (pr)
With ABS brakes



T/L Chrome Solid 16" Front Wheel 2000-06

Bolt-on wheels fit 2000-06 FLST/C/F/N models.

70729 41031-00



T/L Chrome Laced Front Wheel Assemblies

PCP	Size	Application
70725	16"	Features aluminum hub. FLT, FLTR, FLHT, FLHS, FLHR 1984-99 (40960-87C)

Wheels

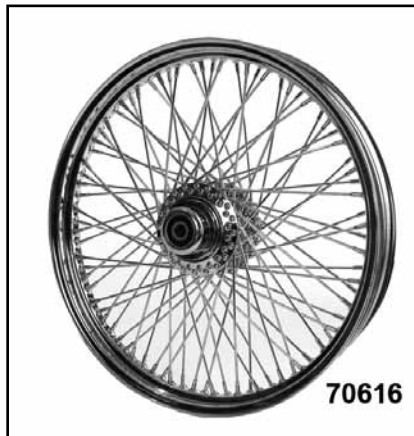
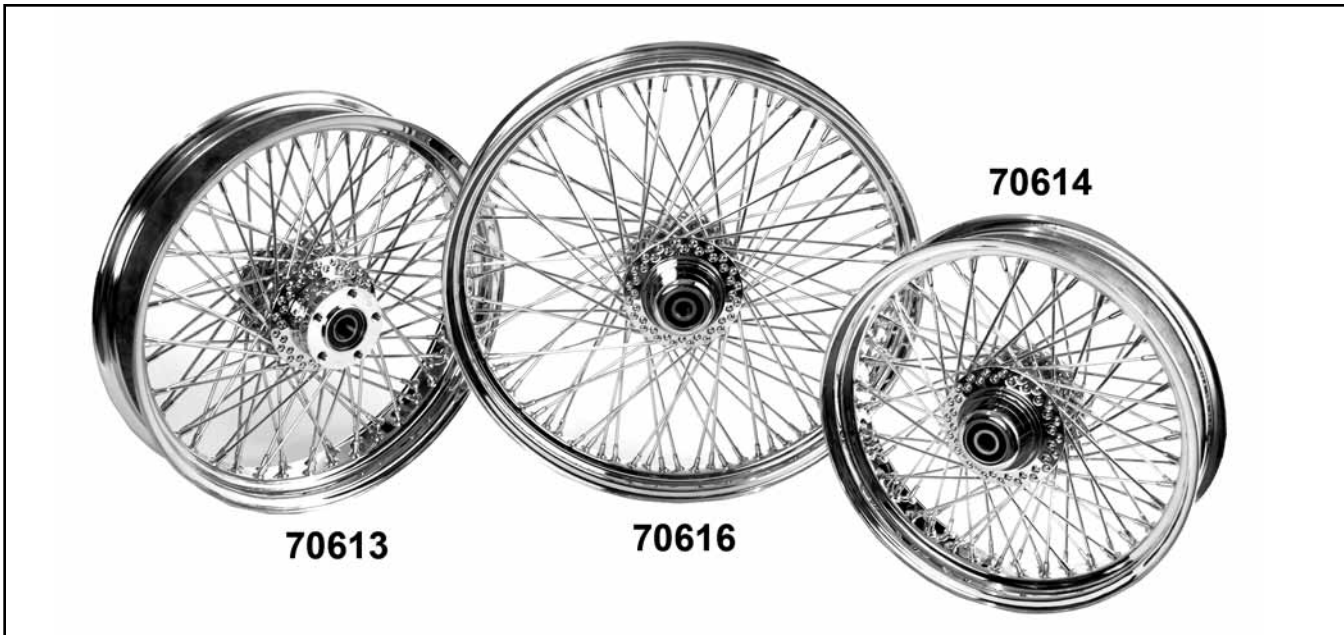

Chrome 80 Spoke Twin Cam Wheel Assemblies from Paughco

80 Spoke design with 6/8 gauge round spokes and custom nipples. Chromed steel rims and chrome forged billet hubs with diamond facets. 3/4" or 1" sealed wheel bearings with center spacers preinstalled. Front wheels available in single disc and dual disc versions. Includes a rim strip for tube type applications only.

Front Wheels

PCP	Size	Disc	Application
70612	16"x3.50"	Dual	2000-07 Touring (1" axle)
70613	18"x3.50"	Dual	2000-07 Touring (1" axle)
70614	16"x3.50"	Single	2000-06 FL Softails (except Springers)
70615	18"x3.50"	Single	2000-06 FL Softails (except Springers)
70616	21"x2.25"	Single	2000-06 FX Softails and Dyna Wide Glides (except Springer models and 2006 Dyna WG)



Rear Wheels

PCP	Size	Application
70617	16"x3.50"	2002-07 Touring models and 2005-07 Sportster models (1" axle)
70618	18"x3.50"	2002-07 Touring models and 2005-07 Sportster models (1" axle)
70619	16"x3.50"	2000-01 Touring models, 2000-04 Sportsters, 2000-05 Dynas, and 2000-02 Softails (except Deuce and FLSTS)
70620	18"x3.50"	2000-01 Touring models, 2000-04 Sportsters, 2000-05 Dynas, and 2000-02 Softails (except Deuce and FLSTS)
70621	16"x3.50"	2003-06 Softails (except Deuce and 2006 models with 17"x6" cast wheel)
70622	18"x3.50"	2003-06 Softails (except Deuce and 2006 models with 17"x6" cast wheel)

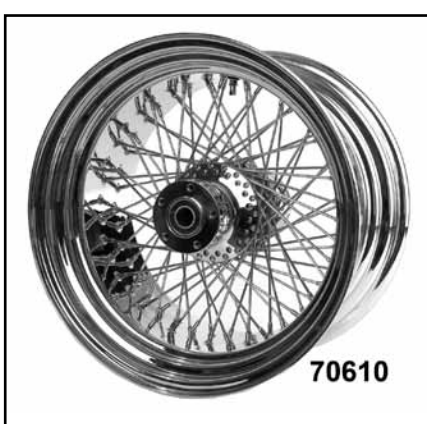
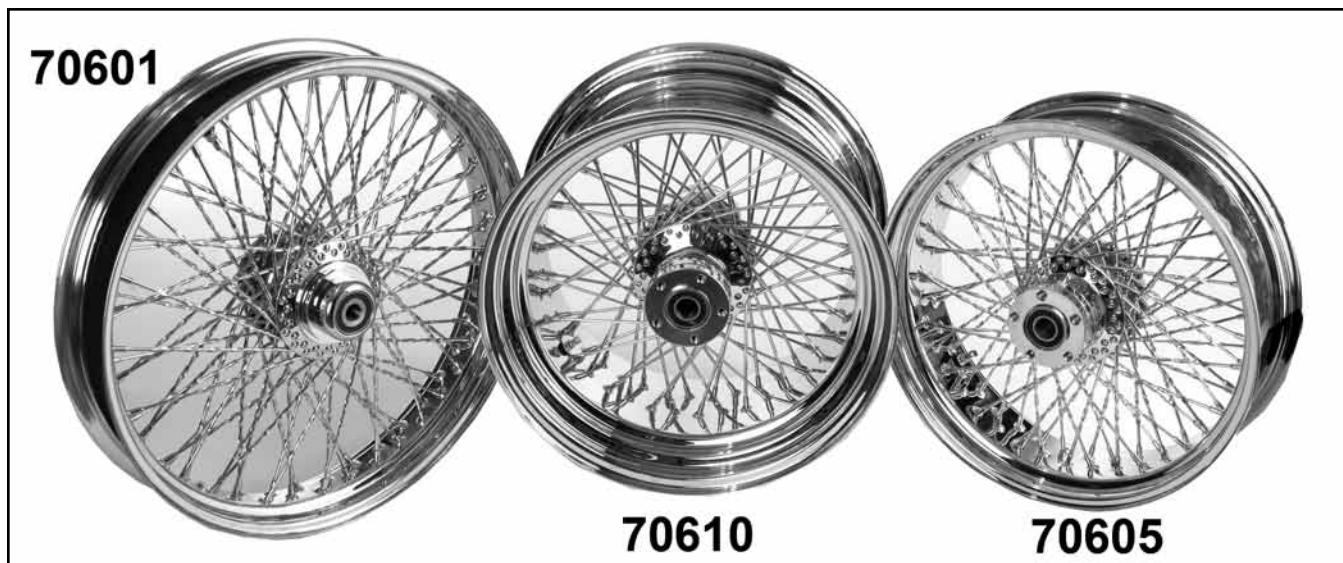

Chrome 80 Spoke Wheel Assemblies for Custom Wide Tire Applications from Paughco

80 Spoke design with 6/8 gauge round or twisted spokes and custom nipples. Chromed steel rims and chrome billet hubs with diamond facets. Each wheel has chrome valve stems and 3/4" or 1" sealed wheel bearings with center spacers. Silicone sealed spoke wells for tubeless tires. Front wheels available in single disc and dual disc. Rear wheels wider than 5.50" have three bearings (two on the drive side for extra support). Wheels require the use of 2000-on brake rotors and pulleys.

Front Wheels

PCP	Size	Disc	Spokes
70600	21"x3.50"	Single	Round
70601	21"x3.50"	Single	Twisted
70602	21"x3.50"	Dual	Round
70603	21"x3.50"	Dual	Twisted

Rear Wheels

PCP	Size	Spokes
70604	18"x5.50"	Round
70605	18"x5.50"	Twisted
70606	18"x5.75"	Round
70607	18"x5.75"	Twisted
70608	18"x8.50"	Round
70609	18"x8.50"	Twisted
70610	18"x10.5"	Round
70611	18"x10.5"	Twisted



Wheels



Chrome 60 Spoke Wheel and Tire Combination

Wheel includes 200 series Avon tubeless tires. (not mounted)

PCP	Size
70911	16"



Chopper Style Wheels

In spool or 3" wide mini brake design which includes anchor bar and cable. Both include 5/8" I.D. bearings.

- | PCP | Type |
|-------|-------------------------------|
| 70776 | Mini-brake wheel 21" x 1.85" |
| 16099 | Shoes for above |
| 70777 | Spool style wheel 21" x 2.15" |
| 15519 | Bearing for above (each) |
| 27377 | Brake cable for above |
| 27378 | Front brake arm |
| 27379 | Front brake stay bar |
| 27380 | Chrome BTE brake handle |
| 27381 | 5/8" x 9" Acorn style axle |
| 27382 | 5/8" x 9" Pike style axle |



Narrow Belt Kit

This kit allows the use of a wider tire on 1996-99 FXDWG models. Kit includes belt, pulley, and black lower belt guard. Replaces 40264-00

91805



Wheel Assemblies

With chrome plated billet hub for FXST models. Features chrome plated, billet hub, chrome spokes and chromed steel rim for either tub type or tubeless application. Rear wheels have extension on pulley side to minimize pulley spacers and bearing is moved outboard to prevent bent axles. Front or rear wheels accept 11-1/2" disc rotors. Single flange are for RSD. 1984-99 hub types use Timken bearings. 2000-on hub types use sealed bearings.

Front 21" Wheel with 1984-99 Hub Type

PCP	Size	Spoke	Axle Size
70941	21" x 2.15	40	3/4"
70900	21" x 2.15	60	3/4"

Rear Wheel

PCP	Size	Spoke	Axle Size	Drive Side	Hub Type
70902	16" x 6	60	3/4"	LH	1984-99
70945	18" x 5.5	60	3/4"	LH	2000-on

Replacement Pieces

- 73618 Bearing set for 60 spoke wheel with 3/4" I.D.
- 73619 Bearing set for 60 spoke wheel with 1" I.D.

4.5" x 18" Chrome Rear Wheels

Accept 150 thru 180 series tires.

PCP	Application
70800	FXST 1986-99
70802	FXST 2000-on

Wide Tire Related



BT Rear Wheel Spacers (BDL)

PCP	Size	BDL
76427	.250"	RPS-0250
76428	.375"	RPS-0375
76429	.500"	RPS-0500
76430	.750"	RPS-0750
76431	.937"	RPS-0937 for use with BDL 1" pulley
76432	1.100"	RPS-1100 for use with CCI wheels
76433	1.250"	RPS-1250



Primary Spacer for Wide Tire Kit

Plain finished spacers fit between the engine and the inner primary when installing a wide tire. The appropriate transmission mounting plate and sprocket shaft extension are required.

PCP	Size
76456	.250"
76457	.500"
76458	.750"
76459	1.00"
76500	1.250"
76501	1.500"
76502	1.750"
76503	2.000"



Spacer for BT Belt Drive Models 1980-85

This .200 thick spacer will allow the proper spacing between the rear belt pulley and the wheel. It can also be used to install custom wheels on BT and XL models 1983-85.

11855 40932-81



Polished Pulley Spacers

Use these threaded spacers to adapt pulley to hub. This version offers extra support by mounting with 2 sets of bolts.

1980-99	Thickness
11880	1/2"
11881	3/4"
11882	11/16"
11883	1"
11884	1.25"
11885	1-3/8"
11886	1.5"



Wide Tire Kits FLST 2000-02

Kits come with a 150 series Dunlop tire, brake caliper, splash guard, wheel spacer and hardware. Kit includes saddlebag hangers and isolators. Installation should be completed by a qualified shop.

91803 FLST/C/F/S (44490-00)

Hub Caps



Chrome Hubcaps for Softail® and FXWG The perfect accessory for the front wheel of most FXWG & Softail models 1984-99. PC #45013 small hub caps simply press onto the wheel hub.

45013 4-5/8" Diameter hub cap fits FXWG & Softail models 1984-99 (except the Heritage & Fatboy).

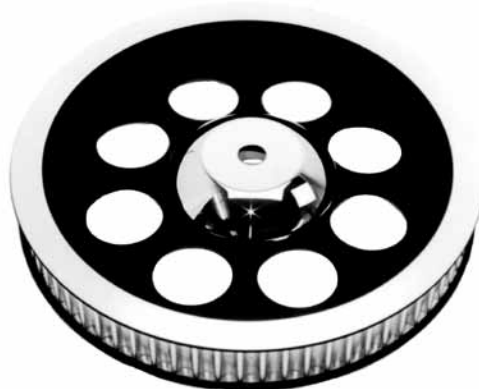

Chrome Rear Hubcap for Belt Drive Models

A neat way to decorate the rear pulley area of all Big Twin belt drive models while hiding the stock mounting hardware. The hub cap is held in place between the axle spacer and swingarm. The PC 4-1/2" hub cap looks great with stock pulleys but better yet when installed with PCP chrome inserts and beltguard.

45015 Fits all BT models with rear belt drive 1980-on.



"Baby Moon" Chrome Rear Hub Cap

45280 1993-99 (43200-99A)



T/L Chrome Dome Front Hubcap

Chrome plated hubcap fits 21" laced wheels.

PCP Application

63033 2000-on FXDWG, FXSTB, FXSTD and FXSTS models with laced wheels (43287-01)



19" Single Disc Front Wheel Hubcap

Made of chrome-plated steel, this 4-3/4" front wheel hubcap will fit all single disc 19" cast wheels on models with 9-spoke mag wheels from 1984-on. It replaces the standard wheel hub plate and screws, and is held stationary between the front wheel hub's external bearing spacer and the front axle.

800 44467-88T

Hub Caps

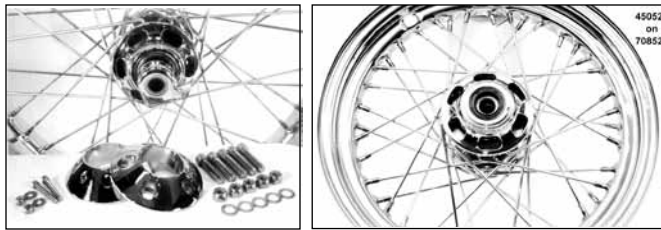

Chrome Die Cast Hubcaps

Allen type, features counter bored holes with socket head screws. Front attaches by 2 screws on FXWG-FXST, rear attaches by 5 pulley allen screws (included). Rear fits cast or solid wheel on 1980-on with belt drive. Slotted front style attaches by 2 set screws for FXST-FXSTS models.

PCP	Type	Style
45016	Front	Allen
45017	Rear	Allen
45052	Front	Slotted
45315	Front	Speedo drive cover



6644



6645

Chrome FL Front Wheel Hubcaps 8"

Full 8" dresser hub cap for wire wheels on 1949-on wide glide type forks.

PCP	Fits
6644	1984-90 FXWG, 1984-90 FXST
6645	1986-96 FLST Single Disc 16" wheel held by snap ring (43067-86)

Jammer Slotted Hub Cover

Use to cover the spoke flange on single disc front ends. Aluminum with hardware to fit FXST and FLST 1984-99 with single flange steel hub.
45328



45015



45322

4 1/2" Chrome Hub Caps

Fits between hub and axle without additional hardware.

PCP	Application
45015	Rear 1984-99 FXST-FLST
45013	Front 1984-99 FXST-FXWG (4-5/8")
45321	Front, Mag 1984-on FX-XL-FXR
45322	Front, Mag 1990-99 FLSTF

Flat Mini Hub Caps for Late Model Wheels

Measuring just over 2" in diameter, each one is held in place between the axle or swingarm and the wheel spacer. **Sold each.**

PCP	Description
45318	Fits the right side of all single disc FX, FXR or Sportster® models with Narrow Glide front ends 1984-99
44096	1996-on



T/L Billet Chrome Rear Hubcap

Small chromed billet hubcap is designed to work with chrome sprocket covers.

PCP	Application
62033	All 2000-06 Softail models except FXSTDSE/2 (43253-00B)

Front Axle

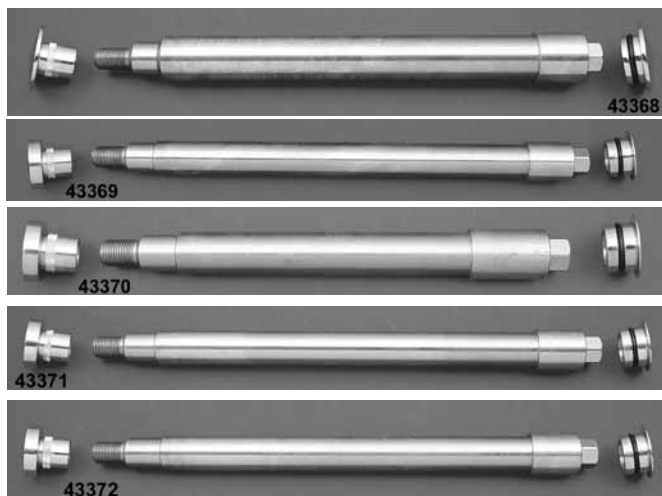

Chrome Flush Mount Front Axles

PCP	Application
43368	2000-on FLT (1")
43369	1984-99 FLT
43370	1988-05 FXR-FXD (39mm)
43371	1984-05 FXST-FXDWG
43372	1986-06 FLST



Chrome Front Axle Caps FLHT/R 2000-07

44312 Set



Chrome Axle Nut Cap Set

Features an internal hex to allow more thickness for the set screw threads which eliminates thread stripping. Fits front axle 1984-on FXST/FXWG, FL 1972-99, FXR 1988-94, XL 1988-03, Dyna 1991-on (except FXDWG)

44316

FLH Axle Nut

Cad plated stock type front axle nut. Replaces OEM # 7734W. Each.

12507



Chrome Front Axles (except where noted)

Size is measured from inside of head to start of threads.

Axles only.

PCP	OEM	Fits	Size
43211	41584-86	1987-06 FLST-FLSTF	9 1/4"
43278	41545-07	2007-up FLST/C	
43363	41116-97	1997-02 FLSTS, Zinc	
3677	43346-83B	1984-99 all FLT	9 3/4"
		1993-05 FXDWG	
		1984-06 FXST	
43249	43364-00	2000-06 FLT, zinc	
43251	41547-07	2007-up FLT	
		2007-up FXST	
43210	43895-87B	1988-99 FXR,	6-3/16"
	(39mm forks)	1987-99 FXD-XL	
43245	43895-00	2000-05 FXD-XL	
43250	43895-00	2000-03 FXD-XL, zinc	
66013	43758-04	2004-05 FXD	
43286	40428-06	2006-07 FXD	
43287	41628-08	2008-up FXD	
66012	40936-06	2006-up FXDWG (1")	
43272	40936-06	2006-up FXDWG (1"), zinc	
43288	43354-00	2000-up FXSTD	
43248	43354-00	2000-06 FXSTD	
43279	41549-07	2007-up FXSTD	
43289	41348-08	2008-up FXCW	
43212	41109-88	1988-96 FXSTS	
3679	43863-84	1984-86 FXE	6 1/2"
	(35mm forks)	1986-87 All XL-XLS	
		1986-87 All FXR-FXRS	



Front Axle Covers

Chrome plated pike style covers fit most 1/2-20 threaded axles. Fits 1980-on FL, FLHT, 1980-86 FXWG, 1984-on Softail (except Springer), 1988-94 FXR, 1991-on Dyna (except Wide Glide).

72263



Chrome Front Axle Nut/Spacer Kit

Fits 2001-06 FXSTD and FXSTDI.

72211

Front Axle

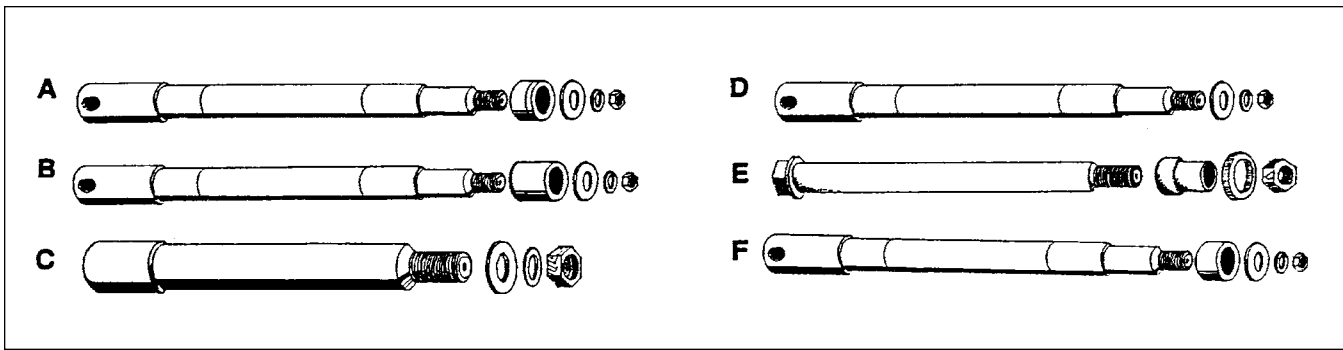

Chrome Front Axle Kits: Includes plated axle, nuts, spacer and hardware. Axle sleeve included when required								
Application	Kit	Spacer	Nut Kit	Axle	Axle OEM	Fork (mm)	#	O.D.
1984-86 FXWG 1984-06 FXST	43329	2261	5360	3677	43346-83B	41	B	.750"
2007-on FXST	43269				41547-07	41	B	25mm
1984-99 FLT	43270		9989	3677	43346-83B	41	B	.750"
2000-07 FLT	43271		72036		43364-00	41	B	1"
2008-on FLT	43290					41	C	25mm
2000-05 FXST-FXDWG	43243		72022	3677	43346-83B	41	B	.750"
2006-on FXDWG				43272	40923-06	49		1"
2000-06 FXSTD				43248	43354-00	41		
1984-86 FXE 1986-87 FXR-FXRS-XL	43333		2057	3679	43883-84	35	C	.750"
1988-99 FXR-FXD-XL	43334		2057	43210	43895-87	39	D	.750"
2000-03 FXD			72028	43245	43895-00	39		.750"
2004-05 FXD	43273			66013*	43758-04	39	D	1"
2006-07 FXD	43291					49	H	1"
1988-99 FXSTS	43335	16573	12736 16108* (WASHER)	43212	41109-88		E	.750"
2000-on FXSTS	43274		72032	43212	41109-88		E	.750"
1987-95 FLST-FLSTF	43336	16574	5360	43211	41584-86A	41	F	.750"
1996-99 FLSTF	43275	16586	5360	43211	41584-86A	41	F	.750"
2000-06 FLSTF	43247	72029		43211	41584-86A	41	F	.750"
1996-99 FLST	43276	43018	5360	43211	41584-86A	41	F	.750"
2000-06 FLST	43246		72034	43211	41584-86A	41	F	.750"
2007-on FLST	43277				41545-07	41		25mm
1997-on FLSTS	43362			43363*	41116-97	41	F	.750"
2007-on FXSTD	43292					41	K	25mm

*Stock Finish



FXST Pike Front Axle 1984-99

Fits 41mm fork legs.

43375



Chrome Castle Nut

Includes cotter pin for rear axles 1989-99 (replaces

7987 & 511

12618 Kit

Rear Axles

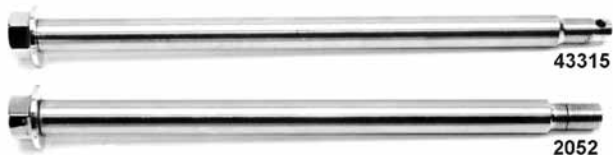

Chrome Rear Axles

Size is measured from inside head to start of threads. Zinc where noted.

PCP	OEM	Fits	Size
2052	41552-73	1973-85 FL, FLH, FX (Chain)	10 3/4"
3683	41580-79	1980-86 FL, FX (Belt) 1984-86 FXWG 1980-86 FXB-FXSB	11 1/4"
5071	41110-79A	1982-on FXR (not '84 FXRT) 1986-99 FXST 1980-on FLT	11-3/8"
43385	41110-89	2000-01 FLT	11-3/8"
43364	41110-89	2000-01 FLT, zinc	11-3/8"
43376	41056-02	2002-07 FLT, zinc	
43386	41056-08	2008-up FLT	
43377*	41110-79A	2000-06 Softail	11 1/2"
43385	41110-89	2007 Softail	
43387	41641-08	2008-up Softail	
43315	41114-90	1990-05 FXD	11-7/8"
43378	41114-06A	2006-up FXD, zinc	12-5/8"
5072	41563-77	1979-87 XL	10 1/4"
43312	41563-77A	1989-04 XL, zinc	10 1/4"

*Note: Includes spacers and nut.



Rigid Frame Disc Brake Rear Axle

For use when 1973-on rear disc brake units are installed on rigid frames. Kit includes .750 diameter axle, nut, special spacer and washers. Other axles sold separately. Spacers may have to be cut to length. Length includes threads.

PCP	Item	Length	Type
3687	Kit	10.5"	BT rigid chain, XL
43318	Axle	12"	Rigid with belt
43374	Axle	11"	Rigid w/chain or belt
3689	Axle	11.5"	Rigid chain
43313	Axle	12.5"	Rigid frame w. disc brake
43317	Axle	12.5"	As above for Swingarm
5073	Collar	1 5/16"	Long (pair)
43104	Collar	1 13/16"	Long (each)
43106	Collar	2 3/4"	Long (each)
43367	Axle	12 3/4"	Rigid frame with disc brake



FXST Rear Axle Kit

All parts chromed for 1986-on FXST-FLST. Items are also offered separately

43314	Kit 1986-92
43316	Kit 1993-99
5071	Axle (41110-79A)
16569	Spacer (41595-86)
5306	Nut kit with washers
43103	Adjuster kit 1986-92 (47579-86)
8934	1986-92 Bolts only (47579-86) (pr)
9515	1993-99 Bolts only (47579-93) (pr)
72023	2000-07 Bolts only (47579-00) (pr)
72517	2008-on Bolts only (4433) (pr)



Chrome Rear Wheel Spacer Set

Fits 2002-on Touring models that utilize a 1" diameter axle.

16610	41163-04
-------	----------



Chrome Axle Spacers

Features 3/4" ID for front or rear wheel use. Sold each.

PCP	Length
16569	7/32"
16593	27/32" (.843)
16594	1/4"
16522	.650"
16595	3/4" (zinc)
16596	1"
72202	1" x 1-1/8" O.D.
16597	1 1/4" (zinc)
16598	1 3/16"
16583	1 7/16"
16576	Rear 2000-07 FXST
16524	1 15/64" front or rear
16599	1 15/64" rear



Rear Axle Nut & Washer Kit

Chrome plated heavy duty machined steel washers prevent distortion of square swingarms on all Big Twins 1973-on and Sportster 1979-on.

5306 Kit

Rear Axle

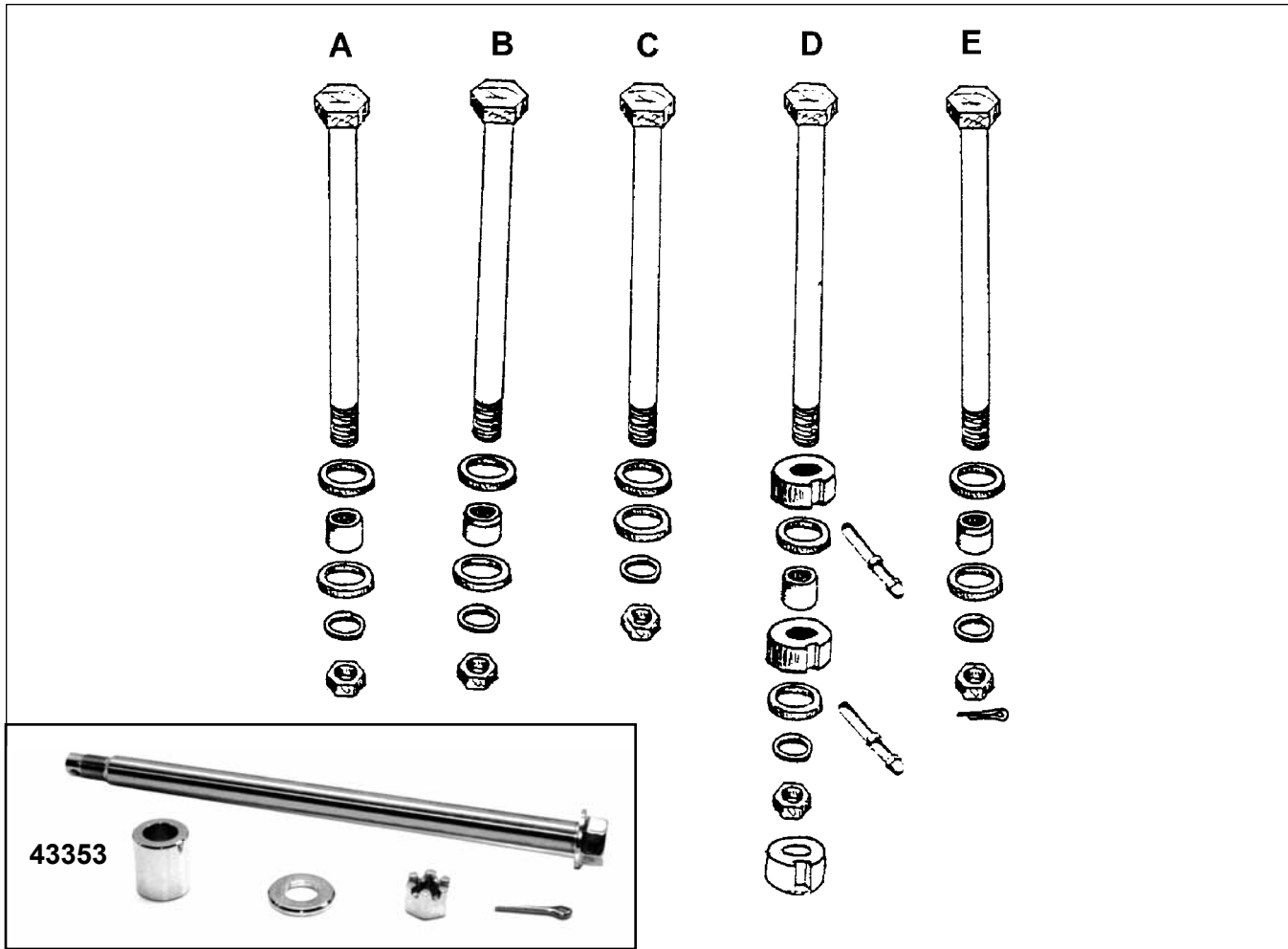

Rear Axle Kits

Kits contain: chrome axle, nuts, sleeves, and spacers for each application. Nut kit includes chrome axle nuts and outer sleeve. Sleeve is included in items A, B, and C.

#	Compl. Kit	Spacer	Nut Kit	Axle	OEM#	Description
A	43347	16593	5306	2052	41552-73	FX-FL 1973-85
B	43348	16571	5306	3683	41580-79	FL -FX 4 speed w/rear belt 1984-86 & 1984-85 FXST
C	43350		5306	5072	41563-77	XL 1979-85
	43319					FLT 2002-07
D	43314	43013	5306	5071	41110-79A	FXST 1986-92 (13 pc kit)
D	43316	43013	5306	5071	41110-79A	FXST 1993-99 (14 pc kit)
	43253	72026		5071	41110-79A	FXST 2000-06
	43383					FXST 2007
	43384					FXST 2008-on
	43254				41110-79A	FXSTD 2000-05
E	43352	16572	5306	5071	41110-79A	FXR 1982-94
E	43353	16583	9812	43315	41114-90	FXD 1990-99
	43320	72038			41114-90	FXD 2000-05
	43337			43378	41114-90	FXD 2006-07
	43338				41114-90	FXD 2008-on



Chrome Softtail Rear Axle Only

PCP	Application
5071	1984-99
43252	2000-06 with cotter key hole

Chrome Axle Spacer Sets

Features a 3/4" I.D. for front or rear wheel use.

PCP	Size
16603	1/8"
16604	3/8"
16605	1/2"
16606	5/8"
16607	1-1/4"



Axle Hardware



5360

Front Axle Nut & Washer Kit

Chrome plated machined steel washer, hex nut, and stainless steel lockwasher fits Harley Wide Glide, FX, or Sportster.

5360 Wideglide 1972-on

Speedo Drive Spacer

Replaces speedo drive on all 1973-on FX-XL-FXR when front wheel drive is omitted.

5068 FX, XL 1973-on

16575 FXST 1984-95



2531

Wheel Hub Inner Bearing Spacer Tube

Available for all 1935-on Twins.

PCP Fits

3305 1978-99 FX, XL front only 2.564" long (43623-78)

2531 1973-on FL front & rear (43603-73)

1973-on rear all FX models

1980-on FXWG front

1982-on XL rear



2053

Rear Axle Spacer (Outer)

PCP Fits

2053 FXST cast/wire 1984-86, FXE-80 wire 1981-86, FX cast 1973-86 zinc (41595-73)

43013 FXST, FLST 1986-99 (41595-86)

16571 FLH-80 1983-on cast or wire, FXWG 1984-86 wire,

FXB,FXSB 1980-86 cast wheel zinc (41592-79)

16572 FXR 1981-91 left side cast or wire wheel, FXRT 1985-on cast wheel zinc (41591-81)

43003 FXD 1998-99 chrome (41591-90)

FLT L/S 1995-98



Chrome Rear XL Axle Kit

Kits includes 11-1/4" bearing surface length axle, nuts and spacers

PCP	Axle Length	Fitment
43302	11-1/4"	1986-99
43303	11-1/4"	2000-03
43304	12-1/2"	2004
43305	12-1/2"	2005-07



16573



2056

Front Axle Spacers (sold Each)

PCP Right Side Application

2261 FXWG 1984-85, FXST 1984-99 zinc (40910-84A)

2252 FXST 1984-on (43358-83A)

16573 FXSTS 1988-96 ground zinc (44029-88)

16584 FXSTS 1997-99 raw (44029-97)

16586 FLSTF 1989-99 zinc (43657-89)

PCP Left Side Application

2056 FL 1973-86, FXWG Classic 1980-83 zinc (41594-73)

16585 FLSTS 1997-99 left

43002 FXD, FXDL 1997-99 chrome (43617-95)

43003 FLT 1995-98 chrome (40915-94)

16574 FLST 1986-95 zinc (43654-86A)

43005 FLST 1996-99 chrome (43683-97)

Axle Hardware



Chrome Axle Spacers

Sold each.

PCP	OEM	ID	Length
43002	43617-95	.750	.930
43003	40915-94	.720	1.253
43004	43674-95	.725	1.412
43005	43683-97	.730	1.350
43006	41591-90	.740	1.435
43007	43654-86A	.750	.750
43008	40910-84A	.750	1.255
43009	43358-83A	.750	.370
43010	41594-73	.745	.655
43011	41595-73	.750	.830
43012	41592-79	.745	1.210
43013	41595-86	.750	.1225
43014	41607-83	.735	.510
43015	47517-58	.745	.380
43016	41591-81	.710	1.265
43017	43648-86	.735	1.270
43018	43657-89	.725	.1050
43019	40910-00	.740	.900
43020	41595-00	.750	1.980
43021	43683-00	.740	.990
43022	43654-00	.750	.475 w/groove
43023	43617-00	.750	.520
43026	43613-00	.755	3.040
43025	43608-00	.745	4.810 (raw finish, not chrome)
43024	43517-00	1.00	4.810 (raw finish, not chrome)



3517

Rear Axle Seal Spacers 1973-on (Sold Each)

PCP	Application
5063	1982-86 FXR's cast or wire wheel 1984-on FL cast wheel only 1984-86 FXST wire wheel, 1982-86 FXWG wire wheel, and 1982-86 FXB, FXSB cast wheel (40906-82)
3517	1983-86 FLH-80 wire wheel (41196-83)
16574	1987-99 FLT, FXST, FXR, 1968-99 all XL (43654-86A)



Smoothie Front Axle Spacer Set

PCP	Size	Application
44128	1"	2000-07 FLT
44129	3/4"	2000-on FLSTF



Colony Chrome Dome Axle Covers

Chrome plated domed covers add a smooth finished look when easily installed with a set screw. Sold in a set of 2.

Front

PCP	Application
72120	1980-99 FL, FLHT, 1980-86 FXWG, 1988-94 FXR, 1984-06 Softail (except Springer), 1991-03 Dyna (except Wide Glide). Fits most 1/2-20 threaded axles
72392	2000-07 Touring, 2004-07 Dyna (except 2004-05 FXDWG, 2007 FXDSE)
72535	2008-on Touring, XL, Dyna and 2007-on Softail
72519	1988-2007 Sportster

Rear

PCP	Application
72443	1989-04 Sportster
72445	2005-07 Sportster
72725	2008-on Sportster
72121	1984-07 Softail
72408	2008-on Dyna and Softail

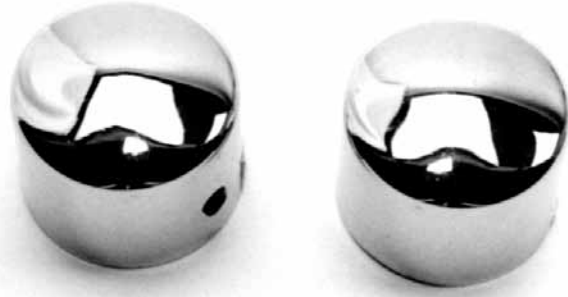

FXST Rear Axle Nut Covers 1984-07

44317 Pair



Rear Axle Spacers

Allow wheels with 1" I.D. bearings to fit 3/4" axle.

Part	Length
16611	1-1/8"
27403	1-1/16"
16614	1"

Axle Hardware



44311

Chrome Axle Cap Kits

Each kit contains the necessary number of chrome axle caps required for your application.

Front

PCP Description

- 44311** 2 Pieces FL 1972-88, FLT/HR 1980-99, FXWG/FXST/FXDWG (not FXSTS)1980-on, FXR 1988-94, XL 1988-03, FXD 1991-03, FXDWG 1993-05
- 44310** 1 Piece, FX 4 speed (except FXWG/FXST) 1981-85, FXR 1982-87 (not FXLR or Sport Edition), XL 1973-87
- 44312** 2 Pieces FLT/HR 2000-on

Rear

PCP Description

- 44315** 2 Piece FL 4 speed 1981-88, FX 4 speed 1981-85, FXST 1984-88, FXR 1982-88 (not Sport Edition), XL 1981-88, FXWG 1982-86, FLH/T 1980-88



Chrome Rear Axle Covers

Chrome plated dome style rear axle covers to fit 2008-on XL.
72725



Ball Axle Cap Kits

Add a touch of class for FL-FLH 1972-88 Glide forks.

426 1972-on (pair)



Colony Rear Axle Nut Kits

Mounting kits for the rear axle on Big Twin models 1973-88, and Sportster® models 1979-88. Available in acorn or custom cap-nut style.

- 5278** Acorn style
5279 Cap-nut style



64010

XL Rear Axle Cover

Customizes the rear axle and swing arm end on XL except 1200S models. Will not fit with rigid saddlebags.

- 64010** 2000-03 (45328-00)
64015 2004 only (45448-04)



Black Custom Rear Axle Spacer

Rear axle short style spacer allows wheels with 1" inner diameter bearings to fit 3/4" axle. Spacer has an overall length of 1-1/16". Spacers outer lip measures .127" and has a thickness of 3.2mm. For custom applications. Sold in pairs

27403

Axle Hardware



Pike Axle Covers

Chrome plated and easy to install with set screws. Set of 2.

Front

PCP Application

- 72393** 2000-07 Touring, 2004-07 Dyna (except 2004-05 FXDWG and 2007 FXDSE)
- 72536** 2008-on Touring, XL, Dyna, 2007-on Softail
- 72264** 1988-07 Sportster
- 72263** 1980-99 FL, FLHT, 1980-86 FXWG, 1984-06 Softail (except Springer), 1988-94 FXR, 1991-03 Dyna (except Wide Glide). Fits most 1/2"-20 threaded holes

Rear

- 72260** 1989-04 Sportster
- 72447** 2005-07 Sportster
- 72487** 1984-07 Softail
- 72726** 2008-on Sportster



Chrome Axle Nut Caps Set

For both axle nut and axle head where required, set screws and hex key wrench. Each cap has an internal hex to allow more thickness for the set screws thread, to eliminate thread stripping.

Note: These axle caps will not work on late model rear axles with cotter key locking devices.

Front

- 61232** 2007-on FXST (diecast) (not FXCW/C, FXSD or Springer) 2008-* XL, Dyna & Touring (44117-07)
- 61223** 2000-07 FXSTD (44122-03)
- 44154** 2000-07 Touring & 2004-07 Dyna (not 04-05 FXDWG or 07 FXDSE) (43062-04)

Rear

- 44152** 2000-07 FXST (44256-01)
- 44153** 1991-05 FXD (44262-01)



Rear Axle Kit

Includes axle, pyramid adjuster blocks and chrome nuts. Replaces 41552-73 on 1973-84 chain drive FLH-FX. **43355**

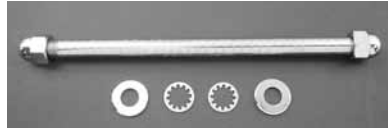

Chome Rear Axle for Softails

For 1986-99 models. Include 3/4" x 13 5/8" axle.

43360 Pike style

43361 Acorn style



FXST, FLST Chrome Rear Axle Kit

Kits includes 3/4" axle, 1-1/4" long chrome spacer, chrome nut kit and adjuster kit.

Axle

PCP Length Fitment

43383 12-1/2" 2007

43384 13" 2008



Grease Fittings 5/16 x 32 Thread

PCP Description

10511 Zinc 1938-on (9851) (10 pack)

10512 Chrome, as above

10513 Zinc, angle 1938-on (5 pack)

10515 Zinc 1979-84 (10 pack)

Axle Hardware



Sportster Rear Axle Adjuster Covers

Chrome plated domed or chopper style pike covers hide the factory hardware and easily install with set screws.

PCP	Years	Type
72446	1993-04	Domed
72261	1993-04	Pike
72448	2005-0n	Domed
72444	2005-on	Pike



Chrome FXST Rear Axle Caps 1987-on

Customize with a clean and simple set of rear axle caps. You'll eliminate an eyesore like the cotter-pinned axle nut on the Softail frame and streamline the rear axle assembly. Easy to install without removing the cotter-pin or re-adjusting the axle. (pairs)

44150	Smooth
44155	Maltese



Axle Adjuster Kits For Softails

Includes collars and adjuster screws with nuts.

43122	1993
43123	1994-99
43124	2000-07



3/4" Axle Spacer Saver

Use to hold axle spacers in place during rear wheel installation.

43359



3/4" Threaded Axles

Features 1 inch of 3/4" x 16" thread at each end. Use with acorn, pike or nyloc nuts as required.

43356	12-3/4" in length (no thread length 10 7/8")
43357	13.5" in length
43358	14.0" in length
43396	15" OAL
43397	16" OAL
44004	Acorn nut set
44095	Pike nut set



Chrome Rear Axle Adjuster and Nut Kit

Kit includes adjuster, collars, axle nut washer and rounded chrome cover. Kit allows use of existing nut and cotter pin.

73521	1986-92
73522	1993-99
73523	2000-07

Colony Axle Hardware

Chrome Front Axle Spacer Kits

Includes axle nut, machined washer, lockwasher and 1 or 2 spacers, depending on application.

Softail Models

PCP	Application
9823	FXSTS 1988-96 grooved spacer (40910-84A)
9824	As above, smooth spacer
72031	FXSTS 2000-on grooved spacer (43683-00)
72032	As above smooth spacer
9925	FLSTF 1990-95 smooth spacer (43657-89)
9922	FLSTF 1996-99 grooved (43657-89, 43674-95)
9923	As above smooth spacer
72029	FLSTF/I 2000-06 grooved (43617-00, 43683-00)
72030	As above smooth spacer
9994	FLSTC 1997-99 grooved spacer (43683-97)
9995	As above smooth spacer
72033	FLSTC 2000-06 grooved spacer (43683-00)
72034	As above smooth spacer
9825	FXST/C/B 1984-96 grooved spacer (40910-84A/B)
9826	As above smooth spacer
9992	FXST/C/B 1997-99 grooved spacer (43683-97)
9993	As above smooth spacer
72021	FXST/B/I 2000-06 grooved (43683-00, 40910-00)
72022	As above smooth spacer

FLT Models

PCP	Application
9825	All models except FLHR/CI 1984-99 grooved spacer (40910-84A/B)
9826	As above smooth groove
9988	FLHR, FLHRCI 1994-99 grooved (40910-84A)
9989	As above smooth spacer
72035	All models 2000-06 grooved (43520-00, 43521-00)
72036	As above smooth spacer
72507	Smooth spacer FLH/FLT 2008-on



Dyna Models

PCP	Application
9825	FXDWG 1984-94 grooved spacer (40910-84A/B)
9826	As above smooth spacer
9990	FXDWG 1995-96 grooved (40910-84A, 43674-95)
9991	As above smooth spacer
9992	FXDWG 1997-99 grooved (40910-84B, 43683-97)
9993	As above smooth spacer
72021	FXDWG/I 2000-05 grooved (43683-00, 40910-00)
72022	As above smooth spacer
9974	All models except FXDWG 1995-99 grooved spacer (43617-95)
9975	As above smooth spacer
72027	All models except FXDWG/I 00-03 grooved spacer (43358-00, 43617-00)
72028	As above smooth spacer

Sportster Models

PCP	Application
9974	All models 1995-99 grooved spacer (43617-95)
9975	As above smooth spacer
72027	All models 2000-07 grooved (43358-00, 43617-00)
72028	As above smooth spacer

9811



Rear Axle Nut and Spacer Kit

Includes chrome plated, slotted nut and a decorative spacer

Fits all Dyna Glide 1991-99 (41591-90)

9811 Grooved spacer

9812 Smooth spacer

Fits Dyna 2000-on (43654-00, 41591-00)

72038 Smooth spacer

Fits XL 2000-on (40910-00, 43654-00)

72039 Grooved spacer

72040 Smooth spacer

9809



Rear Axle Nut and Spacer Kit

Customize the rear axle on all Softails 1984-on with the use of this kit that includes chrome plated, slotted nut and 3 decorative spacers.

Fits Softails 1984-99 (47577-86, 47577-94, 41591-90)

9809 Grooved spacers

9810 Smooth spacers

Fits Softails 2000-on (41595-00, 43654-00, 47577-00)

72025 Grooved spacers

72026 Smooth spacers

Rear Axle Chrome Spring Clip

Fits all 1991-on FL, FX, XL models.

72042 5 pack

