

Section 9

Air Cleaners and Breathers... 32, 50-66

Cables

Barnett 68,70-72

Imported68-69

Choke cables.....48

Decals & Emblems 18-19

Filters (Air) 28-29,32,34, 42

Fuel Line 24

Gas Caps14-17

Gas Tanks.....2-13

Gas Taps27,30-31

Gas Filters..... 26

Keihin Carbs45-48

Manifolds & Clamps 37, 49-50, 52

Paint Saver3

Pingel31

Sportster Tanks12, 20-22

S&S 32-41

Tank Liner9

Tank Mounts 2,4-6,8,13,22

Note: If manufacturer has applied any primer finish, (it is meant only for the protection of the tanks during shipment and storage) it is **not recommended as a primer finish** for paint application without proper surface preparation. Where custom paint is to be applied, the tanks must be pressure tested, then sealed with tank prep PC #78001 and Kreem PC #78002 before painting, to help protect the final finish.

Flatside Gas Tanks



Flatside Fat Bob Gas Tanks 1984-E96

Reproductions of 'flatside' Fat Bob gas tanks. They fit 1984 FXST and all 1985-on models with split tanks. Mounting hardware not included but available separately. Use 1983-E96 screw in gas caps and 13/16" petcocks.

- 6037** 3.5 Gal (61218-85, 61426-85)
- 6480** 5.0 Gal (61211-84A, 61228-84)

Rubber Mounts for Flatside Gas Tanks

These rubber mounts replace the OEM bushings parts used to mount the flatside gas tanks to FX 4 speeds 1985-86 and all Softails® 1984-on.

- 23010** 6 grommets (11447) and 2 spacers (5775)
- 16316** Spacers (5775) (10)



Custom Hardware Kit for "Flatside" Tanks

The beveled washers and mounting screws are chrome plated, and provide a custom look. They replace the OEM screws and washers.

- 24040** All Softail® 1991-99



FXST Lower Gas Tank Mounting Kit 1984-90

Kit for flat side tanks include chrome acorn nuts, thread stud and 2 beveled washers. Also fits 1985-86 FXWG, FXSB/EF.

- 24032**



FXST Gas Tank Mount Kit

Includes all brackets, bolts, bushings and hardware to mount Flat Side gas tanks on 1984-up FXST-FLST models.

- 27042** 1984-90 FXST
- 27041** For flatsides on to 1958-84 frame (some welding required)



Flatside Tank Mounting Kit

Mounts late model rubber mount tanks to 1958-84 FL type frames or aftermarket custom frames.

- 27041** Note: Welding required



Custom Mounting Kit for "Flatside" Tanks

A complete mounting kit to mount "flatside" gas tanks to custom frames (replaces the OEM parts). The beveled washers and countersunk screws are chrome-plated.

- 27040** Fits the 1984 Softail®, and all models with split tanks from 1985-on.

Tank Lifter Kits

Raises the front of the stock gas tank.

PCP	Year	Model	Lift
27000	1997-05	FXDWG	2"
27001	1997-05	FXDWG	3"
27002	2000-10	FXST	2"
27003	2000-10	FXST	3"



Weld-On Rear Tank Dowels

Tapped for 5/16-24 thread.

- 27004**



Gas Tanks

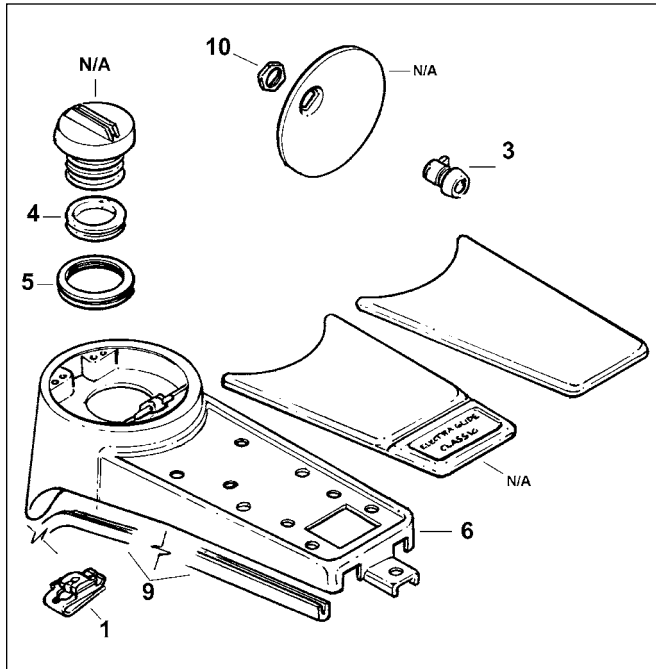

FLT Fuel Tank Console 1988-on

#	PCP	Description
1	12626	Clip nut (7743A) (each)
3	62022	Universal lock, (no key) (61029-92A)
4	79435	Filler cap gasket (61109-85D) (10pk)
5	23048	Boot, filler tube (61112-82A)
6	64803	Console 1998-on (61270-98)
8	29108	Console door 2008-on (61278-08)
9	23049	Rubber moulding 2008-on (71294-08)
10	12627	Lock nut (84850-92) (5 pk)

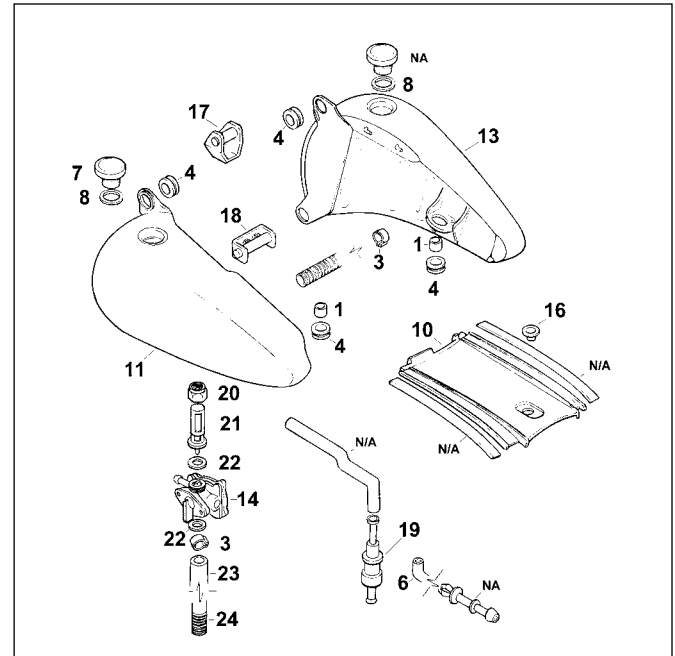

Softail Tanks and Hardware 1992-on

All quantity each unless noted.

#	PCP	Description
1	16316	Spacer (5775) (10 pk)
3	16222	Fuel hose clamp (10014) (10 pk)
4	23010	Grommet, fuel tank mount (11447) (6 pk)
6	23050	Valve to air hose (27102-92)
7	29106	Chrome left gas cap (61103-83B)
8	25163	Gasket (61109-85D) (pr)
10	5452	Tank trim (61155-84B)
11	89101	Left 5 gal. fuel tank 1995-99 FLSTC/F, FXSTS/SB (61228-97)
13	89104	Right 5 gal. fuel tank 1992-99 FLST/F, FXSTSB, FXSTS (61291-97)
14	29403	Fuel valve 1995-* (61338-94C)
16	23501	Spacer (61641-84)
17	29111	Upper tank mounting bracket (61660-85)
18	29112	Lower tank mounting bracket (61667-90A)
19	29113	Vapor valve (62150-85)
20	12593	Chrome fuel valve nut (62161-75)
21	21611	Fuel valve strainer (62166-81A)
22	21613	Valve gasket (62172-75) (10pk)
23	29109	Preformed fuel hose (62356-95)
24	28702	Nylon wiring loom, 1/2" I.D. (63505-84) (25 ft)



Stretch Bobbed Gas Tank for FLT

For FLT models including FLHT, FLHR and FLTR models without fuel injection. Tanks include custom console to cover OEM gauge sending unit. Use standard bung right and left caps and petcock. Shorter seat may be required.

PCP	Year	Type	Gallon
89092	1997-03	Carburetor	5
89093	1989-96	Carburetor	5
89146	1996-06	EFI	7
89147	2003-07	EFI	7
89148	2008-on	EFI	7
59155	2003-on	Dash Panel	



Gas Tanks

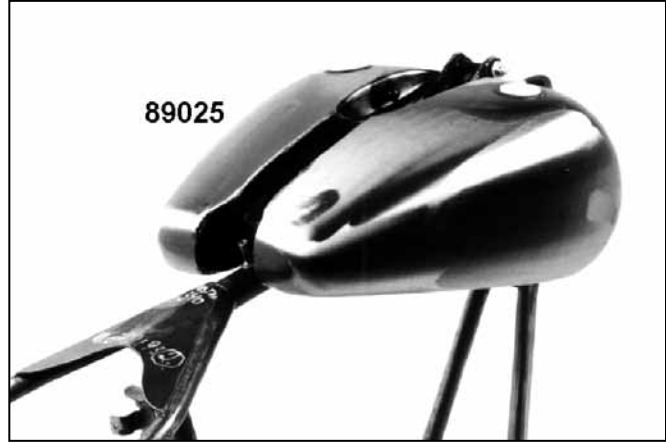
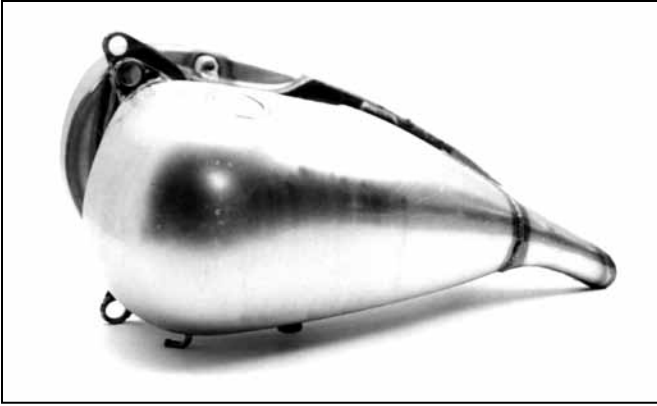

Stretch Bob 3.5 Gal. Flatside Tanks 1984-99

These tanks feature an add-on stretch portion (non gas area) that fills the stock open area. Works with stock dash, panel, caps, 1975-on gas tap and most standard width seats.

89008 Set

FXST "BIG" Flatside Tanks 1984-96

These wider than stock tanks feature extra fuel capacity for longer running. Tanks are wider but, remain the same length and height to allow the use of standard dash, tank panels and seats without modifications. Flatside tanks fit all FXST 1984-96 and most aftermarket frames with Fatbob brackets. Tanks accept stock or custom 1982-on screw in gas caps and late model 13/16" petcocks.

89025 6.0 gallon

89055 7.0 gallon



Dyna Bobbed Gas Tank 1990-95

One-piece tank comes complete with chrome dash panel and all necessary mounting hardware. Gives your Dyna a Fatbob look without all the work.

89002 4 Gallon



Frame Saver Gas Tank Mount Kit

Kit includes front and rear tank mount to mount Bobbed tanks to custom or original frames. A clamping bracket is included to allow for an easy pre-check of tank placement prior to welding the bracket in place.

27301 1985-99 Flat side tanks

Gas Tanks



Bobbed Tank Kit FXR, FXD

Includes chrome cast dash assembly w. a Bob type 6 post key switch, and a plain dash base. Pre 1995 units include a 2240:1 ratio large speedo. 1995-on units include an adapter ring for the existing electronic speedo. 4 Gallon tank.

PCP	Application
90061	FXR 1982-94
90062	FXD 1990-94
90063	FXD 1995-05



1996-05 One Piece 5.1 Gallon Gas Tanks

Are replacement type and accept screw in gas caps on both sides, available separately.

89102 FXDWG



Fat Bob Gas Tank for FXR Models 1982-94

Fat Bob look for all FXR's 1982-94 (will not fit Dyna Glide™). At 4 U.S. gallons, the tank has the appearance of split tanks but is really a one-piece welded tank with 1983-on screw-top filler necks, and 1975-on 13/16" external-thread gas tap fitting. Bolts to the stock mounts and accepts FL-style dash assemblies (not Cateye) with correct dash base. All parts pictured included. The tanks are raw finished and ready for painting.

6478 Fat Bob gas tank for FXR 's



FLT E-Z Bob Tank Kit 1980-99

Kit includes a one piece tank with bung style caps, chrome cast dash, 5 lamp dash base, 6 post bobbed style key switch, 2:1 speedo, front wheel drive cable, and hardware. This kit requires the use of solo seat or FXR style seat for installation. Allows retention of stock gauge housing and FLT key switch, if desired. 4 Gallon tank.

89077



FXDWG Dash Bracket

Will accept 2000-on electronic dash and speedo and FXDWG OEM electronic dash 71246-95 and 71246-99.

73729

Gas Tanks

89094



2" Stretch One Piece Tanks

Fits FXD-FXDWG carb models, accepting bung caps. FXDWG style accept stock dash and speedo panel.

PCP	Description	Gal.
89094	Right Cap fits FXD Smooth 1991-05	4.2
89095	Dual Caps fits FXDWG 1991-95	4.0
89096	Dual Caps fits FXDWG 1996-05	4.0
89121	Center cap fits XL 1982-03	3.5



Colony Tank Rubber Grommets and Spacer Kit

Kit includes 6 rubber grommets (11447) and 2 spacers (5755). Mounts gas tanks on 1984-99 Softails.

72105



Colony Chrome Gas Tank Mounting Kit

Chrome plated countersunk washers and flat head allen bolts to mount lower front gas tank.

72106	FLT 1998-on
72072	Softail 1991-99



Gas Tank Mounting Kit

Chrome nut, washers and studs mount gas tank on 1991-on Dyna.

72076	Acorn nut
72436	Pike nut



Colony Chrome Gas Tank Mounting Kit

Chrome plated custom nuts, washers and stud mount gas tank.

PCP	Application	Nut
72128	Softail 1984-99	Acorn
72077	Softail 2000-on	Acorn
72437	Softail 2000-on	Pike

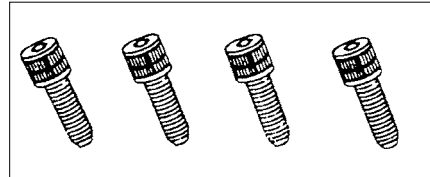

Fuel Tank Custom Allen Mounting Kits

PCP	Description
24059	FXST 1984-89
24060	FXR 1982-on
24061	FXRS 1988-on
24062	FXST 1990-99
24063	Dyna 1991-on

Gas Tank



Stock Replacement Carb Type Tanks 2000-06
 Accepts gas cap on right side and fuel gauge on left.
89103 5.1 Gal.



89097



89098



Stretched Tank
 Features flat bottom for universal mounting on extended neck frames. 2.5 Gallon tank.
89087



89099



Smooth One-Piece Tanks

Fits 1984-99 FXST models are 4.2 gallon, stretch and includes hardware for mounting. Order stock bung caps separately. Some seats may not match up. #89099 is a 2" stretch, 1 piece tank with a 2" extension weld on.

PCP	Stretch	Application	Gal.
89097	2"	single cap 1986-99	4.2
89098	2"	dual cap	4.2
89099	4"	single cap	4.2

Gas Tanks

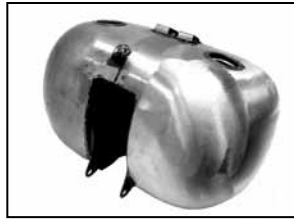

89083



89082



89084



2004-on FXST-FLST Piece Gas Tanks

Fits FXST-FLST models. 5.1 gallon tanks use stock mount hardware and accept right and left threaded bung cap sets. (Stretch tanks have a 2" extension with a welded seam)

PCP	Type	Model	Year
89082*	Stock	Carb	2000-06
89083*	Stretch	Carb	2000-06 (use stock mounting)
89084*	Stock	EFI	2000-07 (l/s fuel line fitting)
89100*	Stretch	EFI	2000-07 (l/s fuel line fitting)
89109**	Stock	EFI	2008-10 (l/s fuel line fitting)
89110**	Stretch	EFI	2008-10 (l/s OE fuel guage hole)

*Note: Uses right and left bung caps, does not have a provision for installing OEM fuel gauge.

** Note: Has provision to fit OEM fuel gauge in left hand bung hole.

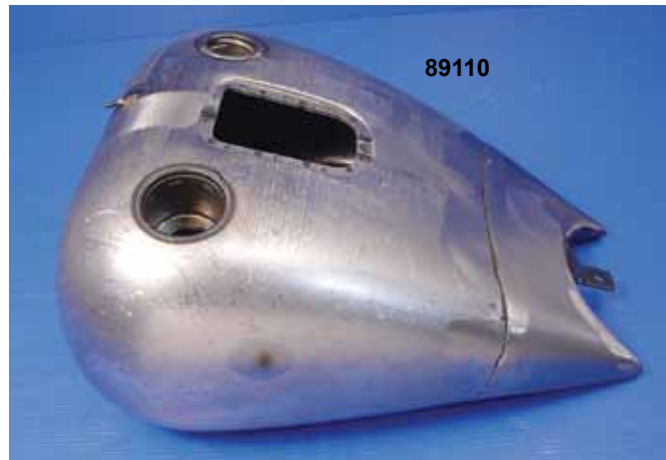

89110



2000-on FXST Tank Mount Kit

Includes all hardware bushings and front bolt with chrome cap nuts.

24105



FXST Tank Mount Adaptor Kit 2000-on

Allows the use of 1984-99 2 piece Bob tanks with their original dash panel on 2000-on FXST models.

27617

Flush Cap Tanks



89037



89038



89044

Flush Mount Cap Custom Gas Tanks from Custom Chrome

These tanks feature locking flush mount gas caps. They are low temperatures welded at welding joints. Locking gas caps and 2 keys included.

Big Twins

89038 6 Gal., FXST 1984-99

89037 4 Gal., 1 piece with dash mounts all FXR 1982-94

Sportsters

89042 3.25 Gal. King tank 1982-94

89043 3.25 Gal. King tank 1995-on

89044 3.2 Gal. Bob tank with dash mounts 1982-94

89045 3.2 Gal. Bob tank no mounts 1982-94

Replacement Parts

16259 Set of keys (pair)

Kreem Tank Degreaser

Perfect for use on new aftermarket tanks. This safe, biodegradable degreaser quickly removes protective oily coating from inside new tanks. Used prior to the Kreem Prep kit this material ensures a clean, oil free surface. It can also be used as a general purpose cleaner/degreaser.

78004 1 pint bottle (each)



78003

78002

78001

Kreem Tank Mask

This water based liquid mask is easily applied to painted tanks and other painted surfaces. It dries to a non tacky film that resists Kreem fuel tank liner and prep B materials. For use on tanks with expensive outsides that need Kreem liner on the inside. Just paint it on, let it dry, prep and coat the inside, then peel or wash the Kreem tank mask away using warm soapy water.

78006 Each



Kreem® Gas Tank Prep Kit and Gas Tank Liner

A two-stage kit that prepares a gas tank for sealing. Tank Prep A is a concentrated cleaner, Prep B a final rinse and conditioner. The Kit removes loose rust and dirt inside the tank while at the same time conditioning the inside of the tank leave in. The kit includes 1 pint of Prep A and 1/2 pint of Prep B. The tank liner produces a "tank within a tank". The liquid quickly cures to a tough, elastomer compound that seals and protects any tank, while preventing rust and leaks. It resists alcohol and gas and withstands most octane boosters. Tanks require one pint of Kreem® per three gallons of tank capacity.

78001 Kreem® gas tank prep kit (2 bottles as pictured)

78002 Kreem® Gas tank liner

78003 Kit of 3 bottles (1 each of cleaner, conditioner and sealer)

Stretch Gas Tanks

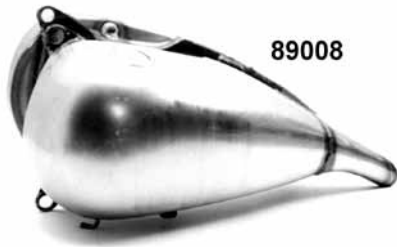

89008



89034



89036

BT Stretch Flatside Gas Tanks 1984-99

These tanks feature an additional stretch that completely fills the space between the tank and seat. Each tank is constructed from heavy gauge steel for use with stock dash, tank panel, late model (13/16" thread) petcock and most standard width seats. Available for standard 1983-on screw in gas caps or for aircraft style (flush mount) screw in gas caps. Stretch portions do not hold fuel and some wide or touring seats will require modification. (Purchase caps separately)

For Screw-in Caps

- 89008 3.5 gallon
- 89034 4.2 gallon
- 89036 5.2 gallon
- 89029 6.0 gallon
- 89050 7.0 gallon

For Flush Mount Aircraft Screw in Gas Caps

- 89057 5.2 gallon
- 89058 7.0 gallon
- 21650 Cap set



89057



89058



21652

21651

Custom Flush Mount Gas Caps

Aluminum, flush mount gas caps customize BT or XL models. Bolt-in type with standard or locking cap. Installation requires modification to the tank filler neck.

- 21650 Set without lock, includes vented and non-vented
- 21651 As above with lock
- 21652 Vented gas cap with outer ring (without lock)
- 21653 Vented gas cap with outer ring (with lock)

Gas Caps Only

- 21654 Vented and Non-vented (no locks) (pair)
- 21647 Vented cap only w/lock (each)
- 21645 Non vented gas cap only without lock (each)
- 21646 Non vented gas cap only with lock (each)

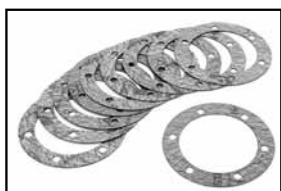

Replacement Parts

- 25284 Mounting ring gasket (10 pk)
- 24554 Mounting ring chrome screws (12 pk)



BT Aircraft Flatside Gas Tanks 1984-99

Designed to accept aircraft style flush mount gas caps and mounting rings (sold separately). The aircraft caps are designed to mount to a special recessed area that keeps the top of the cap flush with the tank surface. Tanks are designed to work with most frames with flatside brackets and large diameter speedometers, dashes, trim panels, and 13/16" threaded petcock. Fits FXST 1984-on and most aftermarket frames with Fatbob brackets.

- 89028 5.0 gallon
- 89052 6.0 gallon
- 89053 7.0 gallon

Gas Tank



2" Extended Tanks 2000-on FXST (5 Gal.)

PCP	Model	Bung
89139	Carb	Single
89141	EFI	Right and left
89142	EFI	Right bung, left gauge 2000-05

Note: 2004-on Carb models use EFI tanks



Wyatt's Curved Fuel Tank

Features radius under side. (24" OAL, tunnel length 19" x 2")
Use #937 gas tap and pre 1975 stock gas cap. 3 Gallon tank.
89125

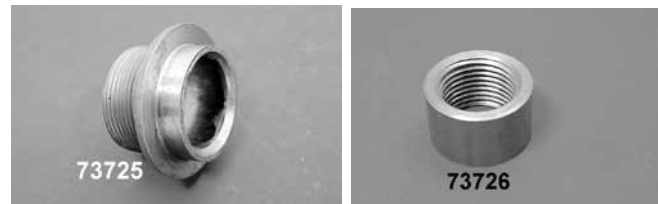

Weld-In Petcock Inserts

PCP	Type	Thread
73725	Male	1975-on
73726	Female	3/8 NPT

FXST Stretched Tanks 2000-on (5 Gal.)

Will accept left side fuel gauge.

89123	Carb 2000-03
89124	EFI 2000-06 and carb 2004-05

Mini Screw-In Gas Cap

Includes weld-in bung.
73730



Flush Tank Mount Kit

Can be welded to flat bottom tank for a clean look.
73724

Gas Tank



XLS 2'' Stretched Tank

One piece stretched tank features curved design with full rubber mounting. For 1995-on models a coil and switch location kit must be ordered separately. PCP# 89111 is a 1982-03 dash type that accepts 2, 3 or cast dash assemblies.

PCP	Type	Years	Gal
89111	Dash	1982-03	3.5
89121	Single cap	1982-03	3.5
89137	Single cap	2004-on	4.0



3.5 Gallon Replica Style Tank 1982-03

PCP	Year	Petcock
89114	1982-03	Left
73607	Cap	



Replica Captain America Gas Tank

Features 2.2 gallon capacity with two 1/4" petcock outlets, straight mount tabs front and rear, and centre fill gas cap location.

89112



Mustang Style Tank

Features single chrome pop-up cap installed.

89144 3.3 Gallon



Ralii Tear Drop Tank

Features curved underside with recessed mount holes.

89126 27" Long 3.8 gallon tank.

Gas Tank



3.3 Gallon Axed Cap

Features dual cap design and universal mount tabs.

89088 Right side petcock, Dual cap

89089 Left side petcock, Dual cap

89090 Left side petcock, Single cap

932 Gas cap, vented (each)

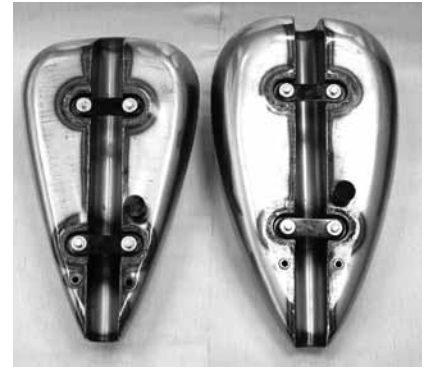

Wyatt Gatling Image Tanks

4" Stretch tank. Pop up tanks include cap.

PCP Gal Type

89118 4.0 Pop-up (23" OAL, tunnel 19" x 1 7/8" ID)

89120 4.1 Screw



2.2 Gallon Koffin Tank

Fits 1-1/2" top frame tubes and accepts 1/4" petcocks. Measures 17-1/2"L x 9"W. Raw finish. Has single front tab and rear U bracket for mounting.

89079 Tank

3085 Cap



2000-on FXST Tank Mount Kit

Includes all hardware bushings and front bolt with chrome cap nuts.

24105



Weld-On Bracket Set

Includes bushings and steel sleeves.

73727



2.2 Gallon Wyatt Pirate Gas Tank

Small size allows for full engine view. Measures 22" long with a 19.5" tunnel length.

89091



Iso Mount Strap Set

Fits bottom of tanks using 3 5/8" C/C holes.

73728

Gas Caps



Chromed Steel Late Threaded Gas Caps

These beautifully plated late styled "bung" steel caps are quality replacements of the OEM part. These caps come with the latest low-pressure relief vent correctly recessed in the cap to clear the filler neck vent tube on 1983-05 gas tanks.

PCP	Description
3083	Set, left and right hand thread
3084	L/S cap only 1983-95 (non-vented) (61103-83)
3085	R/S cap only 1983-95 (vented). Also fits single cap models except FLT(C)/FLHT(C) (61102-83A)
45480	R/S cap (vented), (61272-92A) 1996-05
45481	Set, left and right (61103-83B,61272-92A) 1996-05



Chrome Plastic Threaded Gas Caps 1983-95

A set of plastic bodied, nylon thread, screw-type gas caps for OEM as well as PCP tanks with screw-type filler necks. Available for split tank models 1982-on, with correct pressure relief setting and ratchet "overrun" design. Right side cap is available individually for single tank models including XLX, XLH, XR (but not FLT and FLHT) 1982-on, and most XLS models and all FXR series models 1982-on.

PCP	Description
3086	Set, left and right hand thread 1983-95
3087	R/S cap only for single tank models only (61102-83A) vented 1983-95
3088	L/S cap only 1983-95 (non-vented) (61103-83)



3285



3288

New Style Ratcheting Gas Cap (Stainless)

Gas cap for all 1983-95 Big Twins.

PCP	Description
3285	With vent 1983-95 (61102-83A)
3288	Without vent 1983-95 (61103-83)



Chrome Locking Gas Caps

These caps fit 1983-95 models with Bung type filler cap. Includes 2 keys.

45441	Set
45442	Vented cap only



'Eagle Spirit' Threaded Gas Caps

These plated late-style steel caps are perfect mechanical reproductions of the OEM part. They come with the latest low-pressure relief vent properly recessed in the cap to clear the filler neck vent tube on 1985-05 gas tanks.

Chrome	Gold Overlay	Description
Eagles	Eagles	
45135	45235	Matched set 1983-95
	45236	Vented, right 1983-95
45137		
	45377	Complete set 1996-05



449



450

Custom Gas Cap Covers

Fits 1973-on. Sold each.

450	Satellite
449	Krommet
45265	Krommett 2.880" I.D.

Gas Cap Identification

1983-95 approximately 1.750 O.D. of thread
1996-05 approximately 1.800 O.D. of thread

Gas Caps



Gas Tank Fuel Gauge

PCP	Application
29426	1988-94 FXRS, 1991-00 FXDL, 1995-00 FLHR, 1995-00 FXDWG, 2000 all FXST (75049-88B)
29427	1994-2000 FXD (75067-94A)
29428	2001-on FXD, FXST, FLST, FLHR (75049-01A)



45476

Low Profile Cap Set

Caps feature a polished mirror stainless finish. For use with Bob tanks 1984-on.

PCP	Application
45448	1983-95 Cap set
45476	1996-05 Cap set
45477	1983-95 Vented cap
45478	1996-05 Vented cap



21808



45497

Chrome Skull Gas Caps

PCP	Type
45497	Vented (75097-05)
45498	Non-vented
21808	1983-99 Set (L&R)



45352

Chrome Cap Kit

Features a uniquely designed insert which is permanently installed in the existing bung on bobbed tank sets for 1984-on BT models. Inserts will prevent flaking around the filler neck or conceal existing damage to finish in this area. The chrome caps thread into this insert and act as the actual gas cap. Sold in pairs.

PCP	Application
45352	1996-05
45378	1984-95
26162	Wrench



45352



Chrome Pop-up Cap Set

Fits right and left side on 1983-05 tank sets by pushing in centre cap, the knurled portion appears and allows turning of the cap.

45479	Set 1983-95
45449	Vented cap only 1996-05

Gas Cap Identification

1983-95 approximately 1.750 O.D. of thread
1996-05 approximately 1.800 O.D. of thread

Gas Caps



Low Profile Cap Set

Polished stainless steel cap has a peaked center.

PCP Application

- 59800** 1983-95
- 59815** 1996-05



59801

Lone Star Low Profile Cap Set

Pointed style cap features a star motif and is sold as a set or individual vented cap. Fits all 1983-on models.

PCP Application

- 59801** 1983-95 set
- 59802** 1996-05 set
- 59803** 1983-95 vented cap only
- 59804** 1996-05 vented cap only



Iron Cross Billet Gas Caps

PCP Application

- 59807** 1983-95 (pair)
- 59808** 1983-95 vented cap only
- 59880** 1996-05 (pair)



Billet Flame Cap Set

Fits 1984-99 with vented right cap and non-vented left threads. 1996-on with left side dummy cap to replace fuel gauge.

- 59806** 1984-95 Set
- 59882** 1996-05 Set
- 59883** 1983-05 Vented cap (each)



Smooth Pop Style Cap Sets by Wyatt Gatling

PCP# 59915 is set with left side dummy.

PCP Application

- 59912** 1982-95 Set
- 59913** 1982-95 Vented
- 59914** 1996-05 Vented
- 59915** 1996-05 Set



T/L Gas Cap Medallion w/Adhesive Backing

Fits most 1983-on models (except 2005-06 FXDC, 2004-on XL Custom and FXD, FXDX; FXR with plastic fuel cap, Electra Glide, Tour Glide, Road Glide, VRSC and gas caps with fuel gauges.

- 63022** 99537-96 (each)



Chrome Pop-Up Cap Sets

Features built-in dress ring with o-ring for seal at cap area.

PCP Application

- 59308** 1983-95 Left, non-vented
- 59309** 1983-95 Right, vented

Gas Cap Identification

- 1983-95 approximately 1.750 O.D. of thread
- 1996-05 approximately 1.800 O.D. of thread

Gas Caps

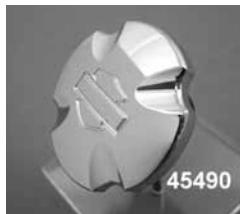

Chrome Billet Cross Gas Cap

Features cross design. #45492 Set includes right side vented cap and left side dummy cap to replace the fuel gauge.

PCP Application

- 45490** 1992-on XL-FXD (not 2004-on FXD/X, 2005-06 FXDC and 2007-on FXDSE) & Softail 2000-on (ea)
- 45491** 1983-99 Set
- 45492** 1996-05 FXST-FXDWG with fuel guage (set)



45485



45486



45487

Chrome Billet Cap Set

Are constructed from solid bar and machined for 1983-95 right and left sides.

- 45485** Low style
- 45486** Medium style
- 45487** Tall style



Chrome Pop-up Flush Mount Cap

Includes vented cap and weld-in steel insert.

45493



59517



59515



Chrome Cap Set 1996-05

Features screw-in right side with left side dummy to replace fuel gauge.

- PCP Style**
- 59515** Low-profile
- 59517** Chrome LTR



Chrome Pop-Up Skull Gas Cap Set

Vented and non-vented set. Fits FL 1982-84, FX 1982-84, FXST 1984-85, and FLST 1986-95.

45499



45449



59808

XL Bung Style Gas Caps 1983-95

Vented caps for single cap tanks. Sold each.

- PCP Style**
- 45449** Pop-up
- 59883** Flame
- 59808** Maltese
- 21644** Profile
- 45236** Eagle Spirit with gold inlay

Gas Cap Identification

1983-95 approximately 1.750 O.D. of thread
1996-05 approximately 1.800 O.D. of thread

Decals

We offer no warranty, nor do we recommend any clear coating to be applied over our decals or tank transfers.

#	PCP	OEM	Description
2	22106	14171-87	Brandy wine, gold, black 2 3/4" x 8 1/4"
3	22110	14165-87	Brandy wine, gold, orange
4	22107	14172-87	Root beer, gold, black
5	22111	14001-82	Gold 1 7/8" x 7"
	22112	14002-82	Gold, red
6	22114	14143-86	Silver, red 1 3/4" x 10 1/2"

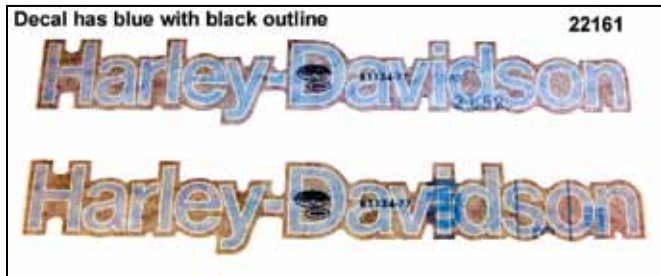
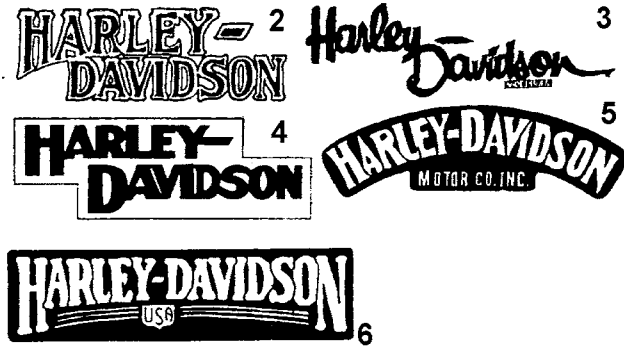

Topline Decals

PCP	Description
22129	Red and black (61908-81A) (each)
22161	Blue with black outline (61134-77) (pair)



Tank Medallion Sets

Sold as right and left set.

PCP	OEM
29614	62093-04, 62094-04
29615	62097-98, 62098-98
29617	62288-05, 62289-05



#	PCP	OEM	Description
1	22133	14261-91	Silver, red orange, black
	22139	14262-91	Silver, meteor, grey, black
2	22135	14289-94	Gold, black
11	22172	14524-96	Burgandy, red



Topline 883 Decals

PCP	Description (Each)
22141	Silver, blue (14232-90)
22143	Light blue, dark blue, silver (14232-91)
22144	Red, gold, yellow (14233-91)
22145	Black, red, gold, orange (14343-92)

Sportster® Tanks



89071



89004

3.2 US allon XL One Piece Bobs

Tanks fit XL models. Bolts to existing holes. Accepts 2 or 3 light dash kits which must be ordered separately. Must use XLS or shorter seat on 1982-on models. Order caps and dash separately.

PCP	Description
89071	1982-94
89127	2004-on
27259	Iso Mount kit 1982-03



XL 3.2 US Gallon Quick Bob Tanks

Feature a smooth top that **does not** accept dash panel or speedo. Includes one piece tank and mounting hardware.

PCP	Description
89004	1982-94 use 83-on screw style caps
89005	1995-03 use 83-on screw style caps (left side tap)



89031



XL Bobbed Gas Tank Kits-----Solid Mounted

Kit includes all parts necessary for a solid mount version. The dash panel accepts FL speedometer but does not accept the stock FL key switch, (plain dash only). Order speedo separately. All kits can be used with a solo seat (or custom seat with a shorter nose like the XLS type). Dash does not accept a speedo with a built in tach. 3.2 Gallon tank.

89017	1982-94
89059	1995-03



89032



89138

3.2 US Gallon XL King Tank

Classic shaped custom tank design features rolled under bottom edge that provides a flowing line to the look of your bike. Tanks are replicas of the 1996-on OEM style tank that are stock on 1997-03 XL. Measure 20" long by 10" wide.

PCP	Years	Tap Side
89031	1982-94	Right
89032	1995-03	Left
89138	2004-on	Left (62213-04)

Note: The zinc-chrome primer is for the protection of the tanks during shipment and not recommended as a base coat for paint application. As with any fuel tank, particularly one where custom paint is to be applied, the tanks must be pressure tested, and temporarily mounted to frame to check clearances, then sealed with tank prep (PC #78002) before painting.

Note: When installing on 1992 to 1994 models and disconnecting or eliminating the OEM continuous venting system, you must replace the stock vented cap with an earlier version screw cap.

Sportster® Tanks



“Standard” Gas Tank for Sportster

OEM-styled Sportster High-Tunnel Tank features stock mounts. 2.4 U.S. gal. capacity. Uses 1975-on style gas tap.

PCP Fits

6034 1982-92 (61023-83)
89035* 1993-03 (61264-93)

*Uses late type screw-in cap

“King” Gas Tanks for Sportster

King tanks are made 2” wider than stock, to give you that needed extra mileage. 3.1 U.S. gal. capacity.(stock 2.2 U.S.) Measure 2” wider than stock and is 17-1/2” long by 10-3/4” wide. Accepts 3/8” NPT petcock PCP# 938 and a screw cap. 1982-on tanks are fitted with correct internal venting system.

PCP Years Tap Side

PCP	Years	Tap Side
6273	1982-92	Right
89020	1993-94	Right (includes rubber grommets)
89140	1982-94	Left



Paughco Porkster Tank for Sportster Models

This 4.1 U.S. gallon axed style large tank bolts on to Sportster models 1952-on. Dual tank left cap is non-functional. Use #932 vented gas cap and stock gas taps. All tanks come with base metal raw finish.

Single Cap	Dual Cap	Fits	Tap Side
89012	89014	1982-94	Right
89018	89019	1995-03	Left
89131	89132	2004-on	Left



Dynaglide and FXR Bobbed Gas Tank Kit

Features one piece 4 gallon design, which includes chrome bung style late caps, and all necessary mount hardware for installation. Kit also includes a complete 3 light dash kit which includes a plain dash base without wiring, Bob style speedometer, a 43” speedometer cable for front wheel drive application and a late Bob type 6 post chrome key switch. Units for 1995-up do not include speedometer or cable, but include bracket to mount stock electronic speedometer.

PCP	Years	Ratio	Model
89015	1990-94	2240:1	FXD
89033	1995-05		FXD
89024	1982-94	2:1	FXR



Fat Bob Tank With Dash Kit

Kits fit Sportster models and feature rubber mounted one piece tank with 3 Light dash kit consisting of: mount plate, 2:1 ratio Bob speedo, 42” cable for front wheel drive, and late Bob key switch. Kit also includes chrome caps and all hardware necessary for installation.

PCP US Gallon Tank Kits

89023	3.2 XL 1982-94
89065	3.2 XL 1995-98 adaptor for digital (no speedo in kit)

IMPORTANT: To eliminate any potential problems with your gas tank we recommend that you pressure test, seal and mount your tank before painting.

Sportster® Tanks



3.2 Gallon E-Z Bob Tank Kit XL 1982-98

Tanks feature one piece design, chrome bung style late caps, chrome cast dash kit and installation hardware.

- 89073** 1982-94
- 89074** 1995-03 No speedo
- 89145** 2004-on



Chrome Sport Bob Tank Mount Kit

Kit allows you to mount Sport Bob tanks on Sportster models. Kit includes switch cover, horn relocation bracket, choke bracket, coil bracket and hardware.

- 73514** For use with PCP tank #89071 and #89004

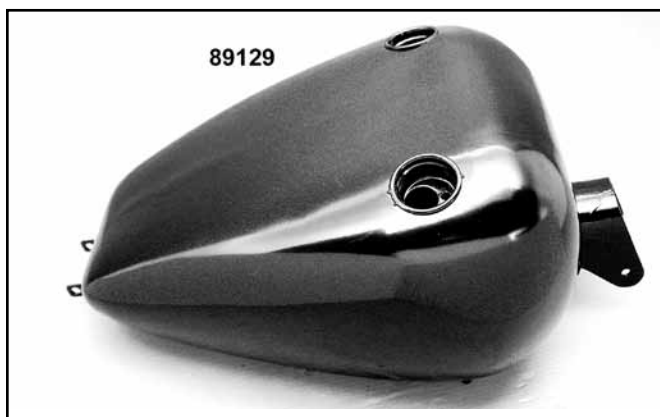

3.2 Gal. XL Quick Bob Tanks 2004-on

- | PCP | Application |
|--------------|-------------|
| 89129 | Smooth |



Gas Tank Mount Kit

Fits 1995 model tank, PCP #89071.

- 27153**



Colony Chrome Gas Tank Mounting Kit

Chrome plated custom acorn nuts, washers, studs, spacers and grommets to mount gas tank on Sportster 1996-on models.

- 72107** 1996-03
- 72265** 2004-on



Braided Steel Crossover Lines

Lines include chrome ends, seals and a protective clear plastic tube.

- | PCP | Application |
|--------------|--------------|
| 77625 | 1993-05 FXD |
| 77627 | 2000-05 FXST |
| 77626 | 1986-99 FXST |



Iso-Mount Kit

For XL Bob tank kits.

- 27259** 1982-03
- 73514** 1995-on Coil mount kit

Gas Tank Related



T/L Fuel Tank Sender Units-USA

PCP	Application
29128	FLT 1984-87 (75037-84)
29129	FLT 1988-95 (75040-88A)
29131	FLT, FLHT 1997-on (75040-97B)
29132	FLT w/fuel injection 1995-on (75071-95)
29133	FXD 1990-94, FLHR 1995, FXDL, FXDWG 1990-on, FXST 2000-on (75062-90A)
29135	FXD 1997-on (75078-97)
29136	FLHR 1996-on (75064-96)

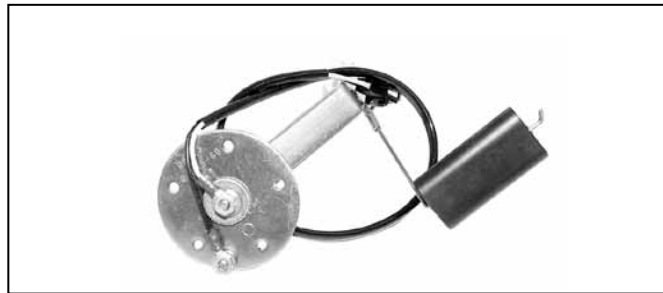

T/L Fuel Tank Sending Unit FLT 1988-95

29129 75040-88A



T/L Fuel Pressure Regulator EFI 1995-00

29125 27219-95A

Fuel Injection Replacement Parts 1995-on EFI

PCP	Application
29175	Fuel injector (27218-95)
29125	Fuel pressure regulator 300 K PA (27219-95)
29176	Fuel pressure regulator 350 K PA
29177	Fuel injector (27609-01)
29178	High flow fuel injector
29179	Barometric sensor 100 K PA (32424-95)
29180	Barometric sensor 250 K PA
29181	Idle air control motor (27628-01)
29182	Idle air control (27658-06)
29126	Air temperature sensor (27270-95)
29183	Engine temperature sensor (32446-99)
29184	Throttle position sensor (27629-01)
29185	Throttle position sensor (27659-06)
29124	Fuel injector (27135-97)
29186	Relay with diode (31511-01B)
29188	Coolant temperature sensor (32315-01)
29190	Gasket and seal kit
29193	Oxygen sensor 1995-99 EFI (27683-06)
29194	Oxygen sensor plug (66054-06)

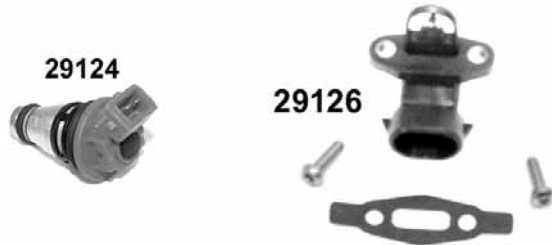

T/L Standard Fuel Injector

For EFI FLT models 1997-01.

29124 27135-97

T/L Standard Air Temperature Sensor

For EFI FLT models 1995-00.

29126 27270-95



Russell Fuel Crossover Lines

These stainless braided hoses have chrome ends that utilize chrome compression fittings in place of the normal hose clamps. Maximum fuel flow is achieved with an ID of 5/16". 1986-99 Softail model lines are also available with a quick-disconnect fitting which allows the tanks to be removed without having to drain them first.

PCP Application

77623	1991-05 Dyna
77624	1986-99 Softail
77628	2000-05 Softail (not for Duece)

Fuel Line



Braided Gas Line Kit

Includes 2 feet of 5/16" braided covered line and 4 econo-seal chrome end clamps.

77425 Kit

Reinforced Fuel Line

Heavy duty reinforced gas and oil line. 1/8" wall. Sold in 25-foot rolls.

PCP	I.D.
3048	1/4"
3052	5/16"
3054	3/8"



S.S. Mini Hose Clamp

Screw type steel clamp.

PCP	O.D.
3846	3/8"-5/8" (10 pack)
3850	1/2"-3/4" (10 pack)



Reinforced Black Fuel and Oil Line (25 Feet)

Neoprene fuel and oil line for all Harley models. Available in shop supply 25-foot rolls, this top quality line is reinforced with high strength rayon. Neoprene outer cover resists oil and grease for years.

77437	3/16"
3055	1/4"
3056	5/16"
3057	3/8"



5/16 Stainless Steel Gas Line

77433 Sold in 5 foot lengths



Chrome Metal Hose Cover

Flexible spring loaded covering in 3 foot lengths. To install, cut to same length as nose, nose cover will compress under tension to allow installation of hose clamps for a snug fit. Protects from heat and abrasion.

77427	1/4" Fuel line cover
77429	3/8" Oil line cover



Econo-Seal Hose Ends

The ultimate hose clamp. Perfect for all gas and oil lines. Provides additional support. May be used over again. When used with our custom steel braided line they present a custom look. Chrome. 5/16" ends fit 1/4" hose. 3/8" ends fit 5/16" and 3/8" hose.

875	1/4"-5/16" chrome (6 pack)
868	5/16"-3/8" chrome (6 pack)

Tank Hardware



29216



29215



29214

T/L Braided Stainless Steel Fuel Crossover Line

Braided stainless steel crossover line has polished chrome fittings that eliminate the need for hose clamps.

PCP Application

- 29216** 2000-on Softail except FXSTD and FXCW/C (63692-00A)
29215 2000-on FXSTD models (63694-00A)
29214 1986-99 Softail models (63696-00A)



T/L Braided EFI Fuel Line Dyna 2004-05

Braided stainless steel line includes fuel tank and EFI module connectors for easy installation on 2004 Dyna models with fuel injection.

62352 63020-04



61219

T/L Fuel Fitting Covers 2000-03 FI

Chromed billet aluminum cover features a milled emblem and mounting hardware. Cover is contoured to hide fuel tank fittings on fuel injected models.

- 61219** 2000-01 Touring & 2002-03 Softails (62883-02)
63015 2002 Touring (62884-02)



Flex Chrome Hose Covering

Features heavy gauge mylar construction with chrome finish.

- PCP** **25' Length**
77459 1/4"
77460 3/8"
77461 1/2"



25163

79435

Gas Cap Gaskets

Replacement rubber gaskets for aftermarket and OEM tanks. Sold in 10 packs for all 3.5 and 5 gallon tanks.

PCP Description

- 25163** 1982-on (61109-85C) (pair)
79435 As above, James (61109-85C) (10 pack)



Chrome XL Enricher Knob Bracket 2004

This polished and chrome plated bracket includes chrome hardware to mount on 2004 XL 883, 883C and 1200R models.

- 61209** T/L 16358-04
27384 Preston as above



High Flow Fuel Inlet

Replaces broken fuel inlet to the carburetor bowl for modified motors. Fits all Keihin carburetors (Butterfly and CV) 1976-on BT Evo, TC and XL.

44049

Gas Line Filters



Russell Street Fuel Filter

This chromed billet aluminum bi-directional filter is vibration, heat and shock resistant. This easy to install, compact filter features a replaceable 40 micron bronze element that traps tiny particles preventing damage. Can be used with pump gas but is not compatible with alcohol.

- 77692** 1/4" line
- 77693** 5/16" line
- 77695** Replacement element for all Street filters



Mini Gas Filters

These clear mini Gas Filters completely come apart so that dirt trapped in filter may be discarded. The design of this filter helps to prevent water and other agents from passing to the carburetor. The ends are chromed.

- 942** 1/4"
- 943** 5/16"



Chrome High Performance Gas Filters

Alloy case fuel filter with replacable bronze filter element. Available in 2 fuel sizes. Outstanding filtration.

- | PCP | Size |
|--------------|-------|
| 77044 | 1/4" |
| 77045 | 5/16" |



Chrome Billet Filter

Radius style fits 5/16" hose with replaceable filter.
77047



Chrome Billet Fuel Filter

Features high flow design for 5/16" line
77048



Sifton Chrome Compact Fuel Filter

Machined aluminum unit features a stainless steel filter that is washable and reusable. These filters are available in mini (1.750") or micro (.875") sizes.

Mini	Micro	Fuel Line
77037	77039	1/4"
77038	77040	5/16"

Chrome Transmission Vent Canister

Accepts 5/16" or 3/8" hose.
59523



Petcocks



Sifton Max-Flow Chrome Petcock

Features 360 degree swivel high capacity elbow, full reserve nut and delta knob valve control.

PCP Style

- 59813 Round, ribbed cap
- 59814 Round, notched cap

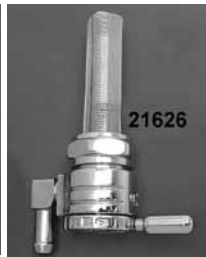

Sifton Chrome Ball Petcocks

Features a stainless steel ball mechanism that provides a secure on/off seal and prevents valve from freezing in the open or closed position. Available with 22mm nut for 1975-on and four outlet positions for any application. also available with 6AN threaded fitting for fuel line hookup using stainless steel hose fittings.

With 22mm Nut

PCP

- 21625
- 21626
- 21627
- 21628

With 6AN Fitting

- 21629



Chrome Fuel and Petcock Cover

Chrome cover installs easily over fuel petcock.

- 61222 2002-06 carbureted models (62968-02)



Mini Petcocks

These petcocks are 1/4" NPT with a ball shut off

- 73548 With reserve, straight down
- 73549 With out reserve, 90 degree



Chrome Billet Petcock

Features on/off and reserve positions.

PCP Side

- 59810 Left
- 59811 Right
- 59812 Inward



Adapter Bushing

Allows use of carb type petcock on electronic fuel injection models. Sold each.

PCP Model

- 73563 FX-FL
- 73566 XL



Crank Vent

Features replaceable umbrella valve.

PCP Item

- 77070 Canister



Topline Replacement Petcocks

29403 Stock finish as OEM with vacuum (61338-94D)

29455 Stock style XL 1995-on (62169-95B)

“Viton” Petcock Seals

1975-94

This special seal fits behind gas tap faceplate to help eliminate the swelling problems associated with the various types of fuels available (including Ethanol type gasoline).

25280 10 pack

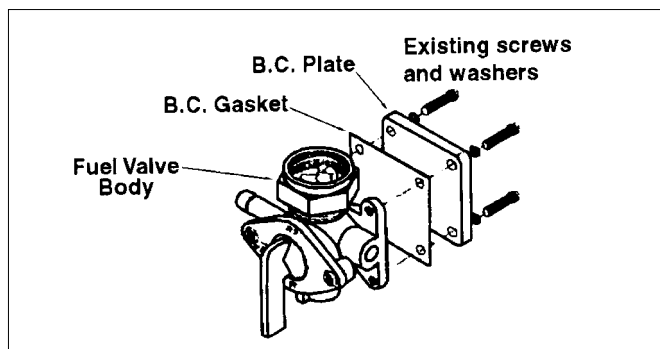

Fuel Valve Body Vacuum By-Pass Kit

Includes plate, gasket, vacuum hose plug and instructions.

41022



Accel High-Flow Fuel Spigots

High flow fuel spigots protect against fuel starve at higher RPM which can cause detonation and eventual engine failure. Accel recommends the installation of a high flow valve with any modification to the motorcycle that increases RPM and acceleration. Spigots features a 100 micron screen filter, on/off, reserve positions and a chrome housing. Available in two styles, straight and rotating, to fit all 1971-92 carb models.

PCP Type

28000 Straight

28002 Rotates horizontally to allow positioning of the outlet at any angle for custom hose routing



689



938

Chrome Late Style Gas Petcock

Has Reserve and Screen. Fits FLH, FX 1975-92 and Sportster 1976-92.

938 Straight outlet (62168-81)

689 90 degree outlet

Hardware

PCP Description

21611 Strainer with reserve tube (62166-81) (each)

21613 Gasket (62172-75) (10 pack)

79443 James, as above (20 pk)

12593 Chrome nut (62161-02) (each)



747



745



746

Chrome Late OEM Type Petcocks

Including filter screen washer, and reserve position for 1975-92 gas tank with male thread outlet.

PCP Outlet

745 Straight (62168-81)

746 Right (rear) (62167-81)

747 Left (forward) (62169-81)



73726



73725

Weld In Petcock Inserts

PCP Type Thread

73725 Male 1975-on

73726 Female 3/8 NPT

Delphi FI to Carburetor Conversion Fitting

Includes gas tank fitting to eliminate Delphi fuel injection and use a carburetor and late style petcock.

10626



Petcocks

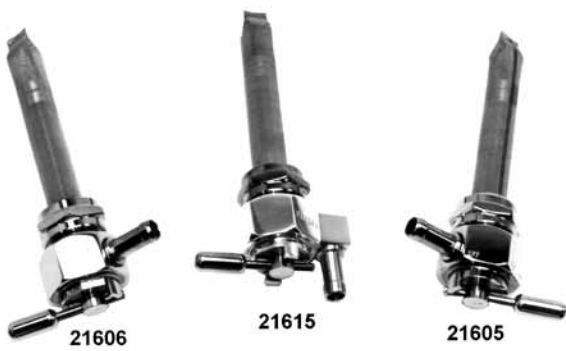

Chrome Pingel Power-Flo Gas Valves

Body of 1-1/8" hex with a total length of 1-1/4". Hose adapter outlet is available with 5/16" hose ID size. O-rings insure leak proof seal. Stainless steel components with stainless steel fuel screen are included. 1975-on type includes nut.

Chrome	Polished	Years	#	Description
21601	21609	1975-on	U	with nut
21602	21615	1975-on	D	with nut
21605	21607	1975-on	L	with nut
21606	21608	1975-on	R	with nut
21610				Adapter Nut Only



Pingel Inline Fuel Filters

These filters are available in chrome or polished finish, and are 1 1/8" long for a 5/16" hose.

- 21618 Chrome
- 21619 Polished
- 21620 Element



Pingel Vacuum Fuel Valve

This vacuum operated fuel valve is a direct OEM replacement and has the highest fuel flow of any vacuum style valve on the market. When the valve is left in the "ON" position with the motor off, the fuel flow will be shut off automatically. These valves are chrome plated and are metric with adaptor nut.

PCP Application

- 21622 Left side mount hose outlets facing forward
- 21623 Left side mount hose outlets facing to the rear
- 21624 Left or right side mount hose outlets down

Pingel Fuel Delivery Systems Are Covered Under One Or More Of The Following Patents: 4,250,921; 4,957,138; other patents pending.

R-Right: Left side mounted, hose outlet facing back.

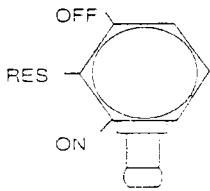

U-Under: Left side mounted, hose outlet facing right.

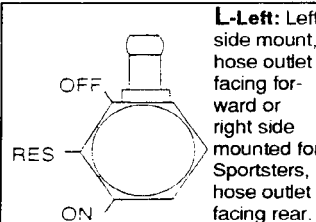
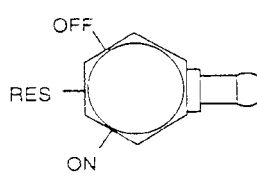

L-Left: Left side mount, hose outlet facing forward or right side mounted for Sportsters, hose outlet facing rear.

D-Down: Left side mounted, hose outlet facing right and down.

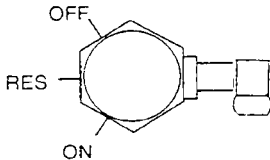

The appearance of these fuel valves are a trademark of Pingel Enterprise, Inc. Patents pending. Made in the USA.

Pingel Power Flow Valve

One piece, billet, brass valve has a single outlet with "U" type reserve and a -6AN threaded fitting for fuel line hook up using S.S. hose and fittings. Line and S&S E & G carb fitting sold separately.

- 21621 Petcock
- 16271 S&S fitting

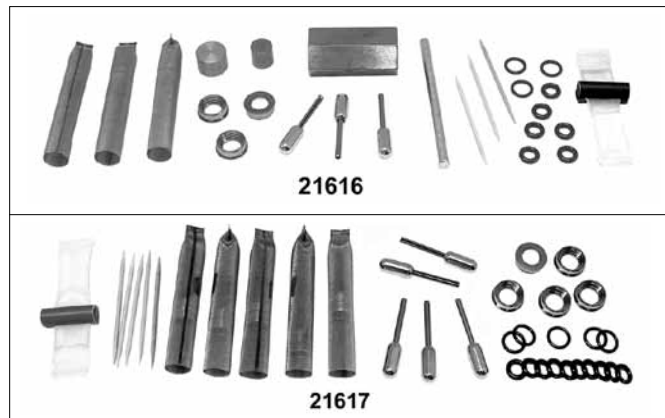

Pingel Fuel Valve Rebuild Kit

This kit was designed to work with Pingel's single or dual outlet fuel valves. The Kit includes: rebuild parts for three valves, all tools needed, and instructions.

- 21616 Fuel valve rebuild kit, complete for 3 valves
- 21617 Fuel valve rebuild components for 5 valves

Air Filters



For Big Twin Models

Uni	Accel	K&N	Depth	Fits
-	-	77729		TC 1999-01 EFI (29462-99)
-	-	77734	1-3/4"	TC Touring 1999-07 carb, all Softail 1999-on, 2002-07 EFI Touring, Dyna 2006-07 (29461-99)
-	-	77733		BT 1995-98 with EFI (29291-95)
77750	77716	-	3-1/4	80" Evo 1993-00 round not EFI (29259-93)
6674	77709	77732	3-1/2	80" Evo 1990-99 round (29259-91A, 29330-96)
6668	77708	77731	3-1/2	80" Evo 1986-89 round (diamond shaped filter) (29259-86)
6665	77707	77730	3	80" Evo 1984-85 round (29259-83T)
6666			2-7/8	FLT, FLHT 1983-85 (Ham Can) (29288-83)
-		77748		Dyna 2008-on
-		77749		FLT, FLHR 2008-12 (29633-08)
		77785		Twin Cam S/E air filter (except 08-12 Bagger & 08-12 Dyna) (29442-99A)



For XL Models

Uni	Accel	K&N	Ht.	Fits
6662			3	XL 1988-92 oval (29086-73)
6669	77704	77736	3	XL Evo 1988-03 oval (29036-88B, 29931-96)
6667	77702	77735	3-1/4	Evo 1986-87 oval (29036-86)



For Aftermarket Models

Uni	K&N	Ht.	Fits
6670	77738	2-3/8	S&S Super B & D
6673	77739	2-3/4	S&S Super E & G
77719*	-		Kool blue for S&S Super E & G
6671	-	2-3/4	S&S 2-Throat
6672	-	2	# 827 Air cleaner (Dragtron)
-	77740		Mikuni HSR 40 smoothbore
-	77741		Mikuni HSR 42/45 smoothbore
-	77742		Screamin' Eagle round (29055-89)
-	77743		Screamin' Eagle tapered (29442-99) (HD-0800)
-	77745		Hyper Charger



* Accel's "Kool Blue" filters (plastic coated mesh, washable and reuseable)

Air Filters



Reusable Paper Air Filters

These washable cotton air filters have the original shape and styling to ensure a proper fit.

PCP	Style	Application
77772	(D)	1990-98 FLST/C/F/N, FLT/C/U, FLHT/C/P/U, FLHS; 1991 FXDB-D/DC; 1991-96 FXDB-DL WG, 1990-93 FXLR, 1991-94 FXR/S/S-CON V/S-SP/T/C/D, 1984-90 FXST, 1989-93 FXSTS, 1990-95 FXSTC (29259-93, 29259-91A, 29330-96)
77773	(H)	1999-07 TC Touring with carb and 2002-07 EFI Touring, all 2001-11 Softail, 1999-07 Dyna (29461-99)
77774	(H)	PCP, as above (29461-99)
77775	(E)	1988-2003 XL (29036-88A)
77776	(B)	Round S&S type "B"
77782	(B)	Round S&S type "E & G"
77777	(F)	Tapered Velo type and S/E TC (except 08-12 Dresser & Dyna)(6-¼ OD x 2-¼ Wide)
77778	(G)	Sifton air power
77780	(I)	1999-01 Touring EFI (29462-99)
77784	(J)	S/E 2008-11 FLHTCUSE/FLHRSE (29244-08)
77783	(J)	2008-12 FLHT, FLHR Touring (29633-08)
77786	(J)	2008-12 FXD/B/C/F/L & FXDWG (29191-08)
77781	(A)	2004-on XL (except CR 1200X) (29331-04)



S&S New Generation Air Filter Element

The new S&S Super E & G filter elements are made with the same filtering material used in many stock cars and drag racers. The new filtering media removes more airborne particles while allowing better air flow. The new filter media is also more durable and lasts longer because it can trap nearly twice as much dirt before becoming clogged. As an added bonus this material can be washed and reused several times before it needs to be replaced.

170054



Hi-Flow Air Cleaner Element

Fits S&S E air cleaners. Kit includes washable 3.5" high filter and mounting studs.

77747

K&N Aerosol Recharger Service Kit

A six step maintenance system designed to recharge any K&N air filter. Restores air flow efficiency. Includes 6.5oz spray oil and 12oz filter cleaner.

21832



Air Filters



1700087



1062448

S&S Single Bore Tuned Induction System

Bolt-on system gives twice the performance of stock intake systems and increases horsepower and torque across the RPM range. Uses air column inertia and carefully timed gas dynamic pressure waves to increase performance. Includes high flow washable and reuseable cotton media. Red filters.

S&S Single Bore Tuned Induction System Kits			
PCP	Fitment	Fuel Delivery	Finish
1700087	1999-13 BT (except 2007-08 FXDWG & 2009 FXDC, FXDF)	Stock CV & EFI Delphi	Chrome
1062448	2008-13 Touring	Electronic throttle Control	Chrome



Shown installed on filter

S&S Washable Nylon Air Filter Cover (each)

Water resistant covers keep out large debris allowing the air filter media to stop small dirt particles from entering your engine. Sold each.

- 1060247 Filter cover
- 171020 Red filter
- 171023 Blue filter



1700054



1700056

S&S Air Stream Stealth Air Cleaner Kits

Features air directional stinger cone inside the filter for a quieter ride. Can also be used with your stock H-D Twin Cam 88, 96 or 103 air cleaner cover or other S&S custom designed covers.

S&S Stealth Air Cleaner Kit With Airstream Cover			
PCP	Fitment	Fuel Delivery	Finish
1700056	1999-12 BT	Stock CV & EFI (except 1999 Softail carb & Throttle By Wire)	Chrome
1700054	2008-12 BT	Stock EFI & Throttle By Wire	Chrome



1700118

1700122

S&S Air Stream Cleaner Covers

Tear drop shaped steel covers fits S&S Super Stealth air cleaner kits. Covers feature screened vent for more air flow without sucking in road debris or rain.

- PCP Finish
- 1700118 Chrome
- 1700122 Black

S&S Air Cleaner

S&S Teardrop Air Cleaner for Twin Cams

with stock carburetor and for 2002 fuel injected models. Owners of 1999-on Twin Cam style engines equipped with stock CV carburetors, 2001-on fuel injected Softails, and all 2002 fuel injected models can enjoy the performance benefit and good looks of an S&S teardrop air cleaner. S&S backplate bolts directly to the stock CV carb or the single throat style EFI throttle body.

Like other S&S air cleaners for stock carbs the Twin Cam style air cleaners feature a uniquely designed backplate with air horn style radiused entryway and a dimpled cover with air directional cone on the inside. Both features help maximize air flow by giving intake air an efficient, easy path to follow into the carburetor or throttle body. Harmful particles are captured by the foam filter element which can be washed out and reused. The air cleaner cover is finished in show quality chrome, which compliments the appearance of most motorcycles. Kits include instructions and all parts and hardware needed to complete the installation.



S&S teardrop air cleaner kit #170117 fits 1991-on Sportsters, 1993-on carbureted Evolution Big Twins, and 1999-on Twin Cam style engines with stock CV carbs in addition to 2001-on fuel injected Softails, and all 2002-on fuel injected models.



Application	Stock CV and EFI	S&S L, H-D, Tillotson, Bendix, Keihin	Super E&G	Super D
2008-13 Touring with electronic throttle control (except Screamin' Eagle 58mm)	1062091			
2001-13 Softail EFI, all 2002-13 EFI (Delphi) (except 2008-13 Touring TBW)	170450 Chrome 1700181 Black			
1999-on Twin Cam carbureted models			170403	
1993-99 Up carbureted Big Twin V2 models			170404	
1990-92 Big Twin V2			170399	170198
1984-89 Big Twin V2		170108	170399	170198
1991-12 Sportster	170448 Chrome 1700182 Black		170404*	
1988-90 Sportster			170399	170198
1986-87 Sportster		170108	170399	170198
1994-02 Buell	170105			
Chrome cover only for Super E & G models			170378	
*Must be used with 3/8" thick insulator block S&S 16-0497 or 16-0498 for sportster 1991-03				



S&S Paper Super E/G Element
170054





S&S Super E & G Velocity Stack Kit
Kit includes polished stack, bracket, and enricher knob.
170485

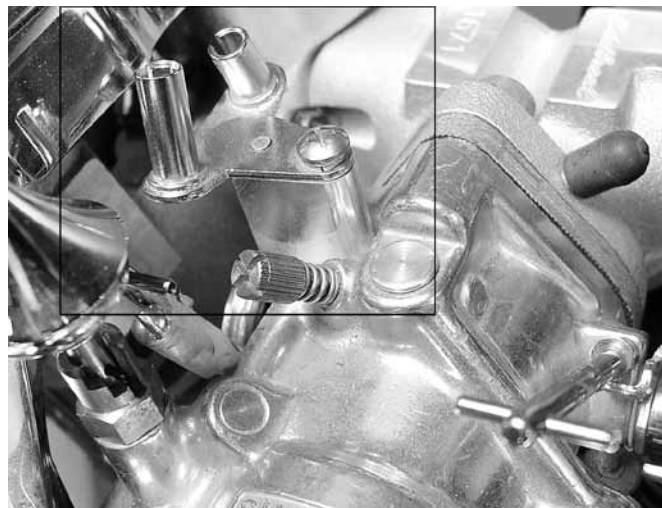

S&S Throttle Cable Adapter Block
Allows use of stock 1996-on throttle cables on Super E carbs.

- 16525** BT
- 16536** XL



S&S Super Allen Screw Set
Includes chrome bowl air cleaner and cover screws.
24077 Super B
24078 Super E & G



S&S Air Cleaner Mounting Screws
Chrome, buttonhead, countersunk allen screws. 3 Pack.
9980



S&S Style Carburetor Chrome Allen Screw Kit
Chrome plated smooth head allen screws replace the stock screws for a more decorative finish. Fits E and G models.
72596



Throttle Cable Adapter Kit
For use when fitting pre 1990 Edelbrock Qwiksilver carb on BT 1990-98 or XL 1988-98 with OEM throttle cables. Use on 1996-on S&S series carb to allow use of OEM cables.
16535

S&S Enricher Assembly
This can be used on S&S Super E & G carbs when an aftermarket air cleaner or velocity stack is used. Does not require lever assembly. Features full on or full off operation only.
73528



S&S Air Cleaner Cover Screws
Set of 3 chrome plated screws.
72518 Phillips 1/4-20 x 1 countersunk



S&S Super E & G

Compatible with Stock Throttle Cables on all Late Model Big Twins.

For the sake of safety, all S&S carbs are designed to use a two pull open/pull closed throttle system. Super "Shorty" carbs for Big Twins are compatible with stock 1981-on throttle cables. Carb kits for late model Big Twins, originally equipped with constant velocity (CV) carbs, include a taller throttle cable guide bracket that accomodates the longer CV style cables. Kits for earlier model Evolution Big Twins which could have been equipped with either a butterfly or CV type carb include both a shorter bracket for butterfly style cables and the tall bracket for CV style cables. Due to inadequate frame clearance the taller throttle bracket can not be used on Sportsters. Therefore, late model Sportsters and Buells require the installation of earlier butterfly style throttle cables.



S&S Super E and G Complete Carburetor Kit Selection Chart

Application	Year	Standard Super E Kit	Standard Super G Kit
BT	1984-92	110407	
	1993-99	110419	
Sportster	1986-90	110408	
	1991-03	110409	110429
	2004-05	110470	
Twin Cam 88	1999-05	110450	
	124" Motors only		110531
Carb Only	All	110420	110421

Note: OEM stock CV carb being replaced with an "E" or "G" will require use of the push-pull cable set-up, as stock on 1981-89.



Cruise Control

Super "Shorty" carbs can easily be installed on motorcycles equipped with factory cruise control. Cruise control adapter kits are available for 1993-97 and for 1998-03 later models. The S&S cruise control kits make any Super E or G carburetor compatible with the stock H-D cruise control. Kits include all parts and instructions needed to complete the installation.

112926 1993-97

112927 1998-03



The original short throttle cable guide #112339 fits the 1981-89 style stock H-D and S&S "butterfly" style throttle cables for Big Twins.

The new longer cable guide #112338 fits the 1990-on "CV" throttle cables for Big Twins.



S&S Super Rebuild



S&S Carb Type	Carb Model	Body Rebuild Kit	Accelerator Pump Kit	Master Rebuild Kit
Super Series	Super E Gas	112906	112918	112923*
	Super G Gas	112907	112918	112924*
	Super A & B Gas 1983-on (wire type mechanism)	112903		112909
	Super D Gas pre 1985 (forked type mechanism)			112915
	Super B Fuel, B Turbo Gas, Turbo Alcohol and fuel	112908		
Two-Throat	1983-on (wire type mechanism)	112905	112916	112919

* Note: When these super master rebuild kits are used to update an early Super E or G equipped with a 360 degree variable position gas inlet fitting, S&S fuel line, #190474 or 190475, with a 90 degree formed end must be used and ordered separately

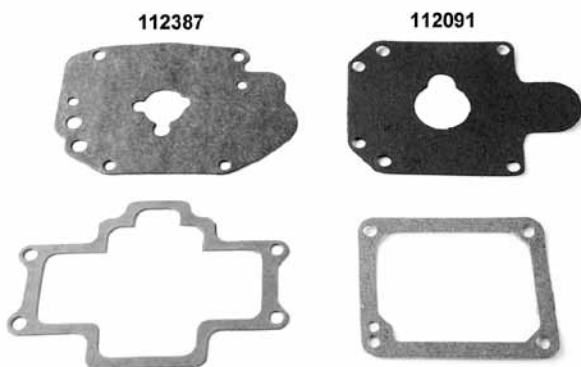

S&S Bowl Gaskets

PCP	Application
112387	Super E and G (5 pack)
112091	Super B and D (10 pack)
112061	"L" Series (5 pack)



S&S Main Jets

PCP	Size (5 pack)
117231	.062
117232	.064
117234	.068
117238	.076

Intermediate Jets

Series 94 jets used to bleed air. Fits all super gas carburetors. Sold Each

Intermediate Jets

PCP	Size
16006	.025
16007	.028
16008	.0295
16009	.031
16014	.032
16010	.033
16011	.036
16012	.040

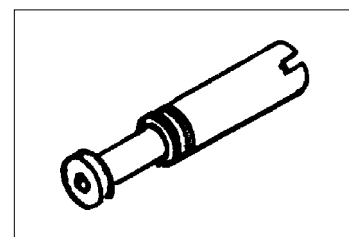

Main Jets (Sold Each)

Use when installing new exhaust system or just tuning for better performance and mileage. For LS, Super Gas & alcohol, and Two Throat (Series #72)



Main Jets.

PCP	Size	PCP	Size	PCP	Size	PCP	Size
16022	.044	16028	.056	16036	.072	16044	.088
16023	.046	16029	.058	16037	.074	16045	.090
16024	.048	16030	.060	16038	.076	16046	.092
16025	.050	16031	.062	16039	.078	16047	.094
16026	.052	16032	.064	16040	.080	16048	.096
16027	.054	16033	.066	16041	.082	16049	.098
		16034	.068	16042	.084	16050	.100
		16035	.070	16043	.086	16051	.102
						16052	.104

S&S Super E & G



S&S Throttle Assemblies 1981 and Earlier Chassis

Fits 1" diameter handlebars, S&S Super E & G; and all other butterfly type carbs with 1981-96 H-D style throttle linkage. Cables measurements are taken from throttle grip to end of cable housing, barrel fittings are soldered in place.

- 190449 48" cables
- 190448 39" cables
- 190482 42" cables

S&S Throttle Cables

Open Side	Close Side	Total Length	Hsg. Length	Description
190432	190433	36"	32"	To 1995, 1981-85 FX and FL
190436	190437	36"	32"	1996-on 883-1200 XL
190434	190435	39"	35"	Softail (FXSTC, FXST, FLSTC, FLSTF) to 1995
190438	190439	39"	35"	FXR 86-94, Dyna 93-95
190446	190447	42"	38"	FXST/C, FLSTC, FLSTF, Dyna 1996-on
190440	190441	42"	38"	To 1995 custom use
190462	190463	48"	44"	1996-on custom use
190464	190465	48"	44"	All FLT to 1995
				All FLT 1996-on and custom applications

Note:

1. Actual cable fitment may vary with the use of aftermarket bars, frame modifications, etc.
2. The "Total Hsg" length includes both the bent metal housing and vinyl carrier together. "Vinyl Hsg" length is for the carrier only



S&S 1" Spacer Support Kit

Required for Evolution or Twin Cam engines with head breather style heads using S&S Super E or G air cleaners.
160058



S&S Manifold Kit for 1984-89 80" Evolution

Converts stock rubber compliance fittings to a more rigid mount system, kit includes S&S manifold, mount flanges, 2 specially molded O-rings, and 2 .350" spacers for spacing out the stock air cleaner or carb mount bracket. This manifold is included in our super kit for Evo 1340cc.

- 161658 BT Evo
- 161650 Sportster 1986-03

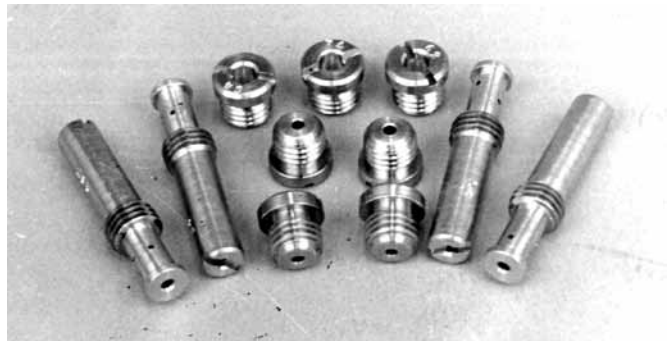

- 117270 Low range jet pack for jetting most stock and moderate performance engines up to about 93" displacement
- 117271 High range jet pack for jetting some stock and all performance engines.
- 117272 Master jet pack for jetting all Super E and G equipped engines (this jet kit will also service most engines equipped with Super Bs)



Quickshot for S&S Super "E" & "G" Carbs

Bolt on accelerator pump that allows the fuel spray to be adjusted for volume and duration. Custom application for all S&S Super "E" and "G" carburetors.
41028



170486



170487

S&S Breather Conversion Kits

Conversion kits include banjo fittings that are sealed with silicone washers which offer a much better seal and greater durability than o-rings. These kits also offer easier air cleaner servicing because the banjo fitting and breather hose are mounted on the cylinder head before the air cleaner back plate is installed and do not need to be removed during servicing. Fits Super E and G cleaner kits 1993-99 BT, 1990-on XL and can be used to retrofit earlier S&S air cleaners. XL kits include a special insulator block and longer manifold bolts.

170486 BT 1993-99

170487 XL with 1-7/8" carbs 1991-2003

170488 XL with 2-1/16" carbs



S&S Manifold #341

For cylinder lengths of 4.650". Fits S&S Super E, Keihin and Bendix.

161650 1-7/8" Rigid mount for XL 1986-03



S&S 1-7/8" Rigid Mount V2 Manifold FL 84-99

For cylinder length 5.375", 88" and 107" BT 1984-99.

161626



S&S Paper Super E/G Element

170054



S&S Super E Chrome Cover for 5 Gallon Tanks

170372



S&S Super E Chrome Cover FL 1993-99

170378



S&S Air Filter Adapter Kit

The high flow filter is 1" taller than our standard filter and features a low restriction, pre-oiled filter element. The low restriction element and larger surface area increase airflow by 37% over S&S's standard filter. The filter and filter adapters extend the teardrop housing out 1". The resulting band of exposed filter peeking out from under the teardrop imparts a high performance street racer look. Kit installs in minutes with no permanent modifications required. These kits are not for use with Super B or D carburetors or Super E and G kits for Buells.

170045 For S&S Super E and G carburetors

170055 Replacement filter

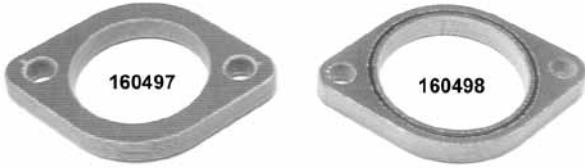

Insulator Blocks

1-7/8" Opening with mounting hole pattern that is identical to stock pattern on Tillotson, Bendix and Keihin butterfly type carbs. Use with all S&S 1-7/8" manifolds. Includes o-ring.

- 160491** 1/4" Thick
- 160497** 3/8" Thick Super E

2-1/16" Opening. Use with all S&S 2-1/16" manifolds, includes o-ring.

- 160492** 1/4" Thick
- 160498** 3/8" Thick Super G

2-1/4" Opening. Use with all S&S 2-1/4" manifolds, includes o-ring.

- 160499** 1/4" Thick



S&S Throttle Cable Brackets

These brackets allow the use of stock type cable on S&S E & G carbs.

- 73587** Fits 1981-89 Short type
- 73588** Fits 1990-on Long type

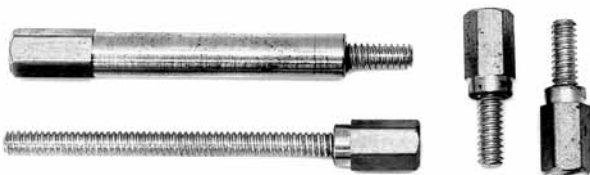

Long Float Bowl Screws for Super E

This facilitates easy removal of float bowl

73536



Idle Adjustment Cables

Includes housing and spring clip. Fits S&S Super E with holder stay.

41039



Adjustable Main Jets For S&S

Fits in the float bowl drain plug below the main metering jet. The recommended main jet is 100 to 104.

Adjustable Enricher for S&S

Replaces the stock fixed enricher, adjusts as bike warms up, and also makes for easier starting. O-rings and instructions included.

PCP	Description
1254	Enricher
3823	Main jet for Super B
530452	Jet installer and removal tool on all B & E carbs



Sifton Carb Hop Up Kit

Kit includes emulsion tube and bomb sight annular booster tube for all S&S E carbs.

73505 Kit



S&S Adjustable Carb Bracket for 'E' & 'G' Models

73589

Sifton Enricher for S&S

Fits Super E & G and B carbs, includes chrome knob.

73586





For S&S E Chrome Velocity Stack Kit
Includes bracket with integral passages. Enricher knob included.

PCP Item
21791 EV and TC-88



S&S 1" Manifold Spacer Block

160357 Sold each



Chrome Alloy Velocity Stacks (not by S&S)

PCP	Size	Application
59007	2.5"	S&S "E/G"
59008	4"	S&S "E/G"
59009		Chrome choke knob



Super Gas Model A & B Body Rebuild Kit

Use on all S&S 1-7/8" Super carbs. Each kit contains 1 ea. throttle shaft, 2 ea. throttle shaft bushings, 1 ea. throttle plate, 1 ea. throttle return spring, 2 ea. throttle plate screw, 1 ea. O-ring, 1 ea. bowl gasket. These kits are for super "A" "B"

41005 Preston
112903 S&S

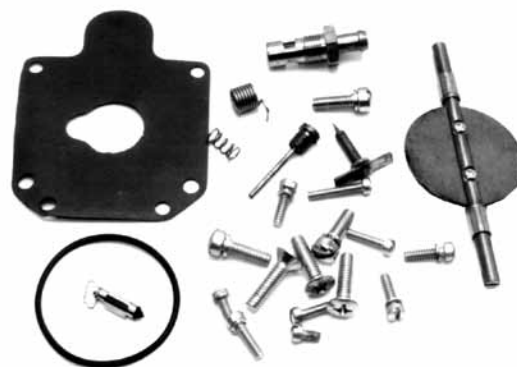

Super Gas Model A & B Body Rebuild Kit

Use on all 1-7/8" Super Carbs. Each kit contains 1 ea. throttle shaft, 2 ea. throttle shaft bushings, 1 ea. throttle plate, 1 ea. throttle return spring, 2 ea. throttle plate screw, 1 ea. O-ring, 1 ea. bowl gasket. These kits are for super "A" "B"

112909 S&S
16015 Preston

Super E Replacement Parts

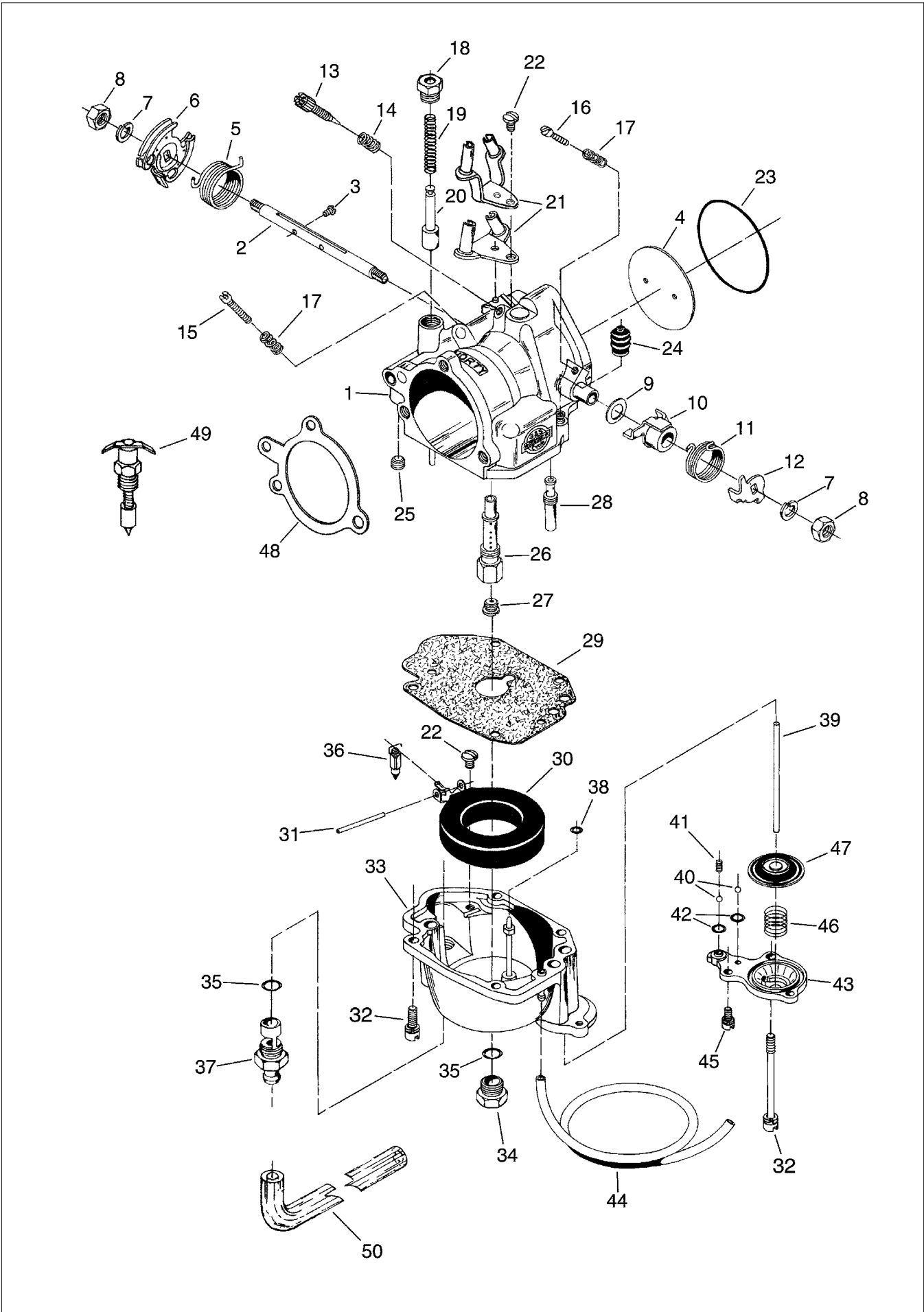

Super E Carburetor Replacement Parts

- | | | | | | |
|---|------------------|--|---------------|---|--------|
| 1. Carb body assembly
1-7/8" E | 112381 | 2-1/16" G (10 pack) | 508093 | 48. Gasket, backing plate
(10 pack) | 170383 |
| 2. Throttle shaft
(includes 2 plate screws)
1-7/8" E | 112383 | 24. Bellows seal (5 pack) | 112279 | 49. Enrichment device
Use with air horn only ... | 112084 |
| 3. Throttle plate screw (2-required)
(10 pack) | 500064 | 25. Bowl vent plug (10 pack) | 500151 | 50. Fuel line w/90 degree bend*-19"
Use with 112465 or 112466
..... | 190475 |
| 4. Throttle plate
1-7/8" E | 112055 | 26. Main discharge tube | 112085 | | |
| 5. Throttle return spring | N/A | 27. Main Jet see pages 9-34 to 9-35 | | | |
| 6. Throttle spool | 112385 | 28. Intermediate jet | see page 9-34 | | |
| 7. Throttle shaft lock washer (2 required)
(10 pack) | 507073 | 29. Bowl gasket (5 pack) | 112387 | | |
| 8. Throttle shaft nut (2 required)
(5 pack) | N/A | 30. Float | 112187 | | |
| 9. Throttle shaft nylon washer
(10 pack) | 507072 | 31. Float pin (5 pack) | 112370 | | |
| 10. Pump actuator lever | 112376 | 32. Bowl screw (10 pack)
10-24 x 3/4" (3 used).... | 500063 | | |
| 11. Actuator spring | N/A | 10-24 2-3/8" (1 used) | 500061 | | |
| 12. Pump actuator arm..... | 112377 | 33. Carb bowl assembly | 112388 | | |
| 13. Idle mixture screw (Each) | 112378 | 34. Bowl plug (5 pack) | 112092 | | |
| 14. Idle mixture screw spring
(10 pack) | 112060 | 35. Seat o-ring (required w/112465 &
112466 only when replaces 360 degree
style fuel inlet (10 pack) | 508095 | | |
| 15. Idle speed screw (10 pack) | 500150 | 36. Needle
1-7/8" E & 2-1/16" G .. | 112195 | | |
| 16. Pump adjustment screw
(10 pack) | 500146 | 37. Seat
1-7/8" E & 2-1/16" G (Replaces 112347)
Uses 112195 needle | 112465 | | |
| 17. Idle speed/pump adjuster spring
(10 pack) | 112053 | Racing only (replaces 112348)
uses 112197 needle | 112466 | | |
| 18. Plunger nut (Each) | 112372 | 38. Ejector nozzle o-ring
(10 pack) | 508096 | | |
| 19. Plunger spring (10 pack) | 112359 | 39. Pump pushrod (5 pack) | 112393 | | |
| 20. Fast idle plunger | 112343 | 40. Ball check 2 required
(10 pack) | 508125 | | |
| 21. Cable guide assembly
For use w/butterfly style cables
.....
For use with CV cables-
(constant velocity style) . | 112339
112338 | 41. Ball check spring (5 pack) .. | 112392 | | |
| 22. Cable clamp/ float pin screw
(10 pack) | 500062 | 42. Pump cap o-ring (2 required)
(10 pack) | 508100 | | |
| 23. O-ring
1-7/8" E (10 pack) | 508094 | 43. Pump cap assembly | 112389 | | |
| | | 44. Overflow hose per 24"
(5 pack) | 190263 | | |
| | | 45. Pump cap screw 8-32 (2 required)
(10 pack) | 500098 | | |
| | | 46. Diaphragm sprig (10 pack) .. | 112278 | | |
| | | 47. Diaphragm | 112282 | | |

* Early Super E carburetors equipped with a 360 degree fuel inlet that require service must be converted to the bottom feed style fuel inlet. To update production Super E and G carburetors equipped with a 360 degree style inlet use 1 of #508009 o-ring, 1 of #112465 seat, and 1 of #190475 fuel line.

Carbs



Mikuni HSR 42 and 45 Total Kits for BT

These kits are complete with all required parts for installation. Kits include HSR 42mm or 45mm carburetor, intake manifold, rubber flange, K&N filter, chrome cover, breather kit and mounting hardware. 1990-on models use stock throttle/idle cable and 1984-89 models require 1990-on cables.

42mm

PCP	Description
59998	1984-99 BT
59999	1999-06 TC

45mm

59993	1984-99 BT
59994	1999-06 TC



Topline Big Bore 44MM CV Carb Kit

Constant velocity carb features a 44mm bore to allow air and fuel delivery even at high RPMs. Installs easily using stock cables but an intake manifold must be ordered separately to ensure proper fitment. Exceptional low and mid range power for race applications. (27934-99)

68400	BT 1990-on & Twin Cam 88 1999-on (27934-99)
68401	Intake manifold TC-88 1999-on (29635-99)
68402	Intake manifold Evo 1340 1990-99 (29636-99)

CV Accessories



CV Carb Upgrade Kit

Includes rebuild kit, vacuum piston, screws and tuner kit. Fits 1988-06 Keihin CV carbs.
41010

Chrome Choke Cable Mount 1993-99

Replaces 69126-92 on 1993-99 FLT-FXST/D models.
27320



System II Atomizer

Screening device which further mixes fuel at face of manifold. The tossed mixture burns more efficiently and completely.

PCP Application

59727 S&S, Mikuni, 40mm Screamin Eagle, 40mm



S&S CV Carburetor Jet Kits

PCP Application

115200 1988-03 XL 883, 1200
115201 2004-on XL 883, 1200
115202 1990-98 BT
115203 1999-on BT



Choke Cables

29118 BT 1988-04 choke cable only (29229-88D)
29123 BT 1988-04 complete choke cable



CV Carb Rebuild Kit

Kit includes seals, o-rings, diaphragm and vacuum piston.
41008

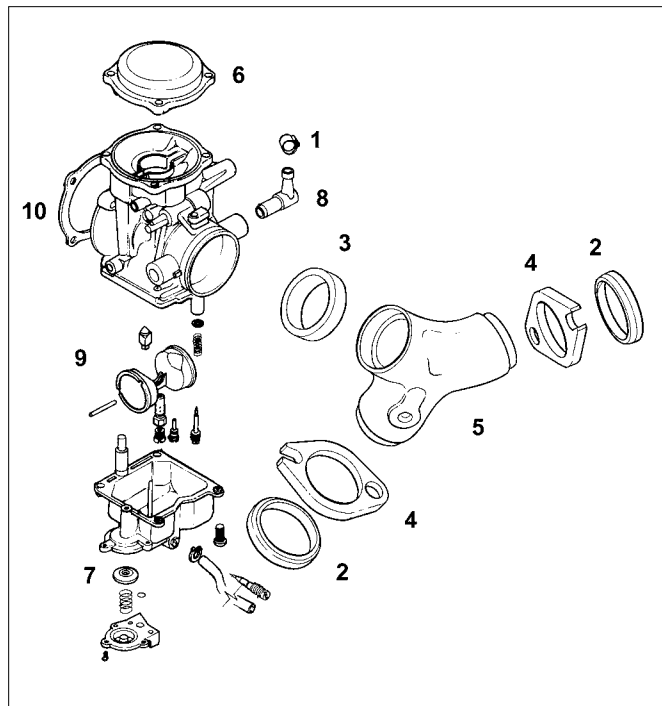

CV Carb Parts FLT, FXR, FXST, Dyna

#	PCP	Description
1	16222	Gas line clamp (10014) (10 pack)
2	14030	Seal, intake manifold to head (26995-86A) (5)
3	14102	Seal ring, carb to manifold 1989-06 (27002-89)
4	41002	Flanges, front and rear (plain) (27009-86A, 27010-86A)
	41003	As above, chrome
5	41032	Manifold, plain (27019-89)
6	21512	Top, chrome cover 1990-99 and 1999-2006 TC (27040-88)
7	41019	Diaphragm, accelerator pump (27361-76)
	79118	James, as above
8	16058	Fitting (27371-76)
9	29163	Float 1989-91 (27576-88)
	29164	Float 1992-on (27576-92)
10	79190	James gasket 1988-on (29059-88) (10 pk)
	25186	Preston as above
	79519	Gasket, injector type 1995-on (29095-95) (10pk)
	79546	Gasket, 1995-on (29062-95B) (10 pk)

Extended Float Bowl Kit

Fits CV carbs for extra capacity and includes Hi-Flow inlet fitting.

59729



CV Accessories



41012

Dynojet

Dynojet carb recalibration kit for stock carbs will work with mild cams, stock or aftermarket exhaust and stock or aftermarket air cleaner.

PCP Description

- 41012 XL 883-1200, 1340 40mm 1989-95 with Accel pump
- 41014 883-1200, 1340 1996-00 with Accel pump
- 41015 .001 BT Evo 1990-99 Thunder Slide kit with Accel pump
- 41023 Twin Cam 88 1999
- 41024 Twin Cam 88 1999 Thunder Slide kit
- 41025 Twin Cam 88 2000-06
- 41026 Twin Cam 88 2000-on Thunder Slide kit



Kinetic-Karb CV Tuner Kit 1990-ON

Tuner kit fits 1989-on Keihin constant velocity carbs, permitting easy tuning of custom air cleaners, cams and exhaust. Kit includes instructions, 3 main jets, needle jet, adjustable needle with spacers and circlips, and spring and drill bits. Dual purpose kit accommodates 1989 models without accelerator pump and 1990-on with accelerator pump.

- 41021 FXST-FLST 1990-ON, FXR 1990-94, FXD 1993-ON, FLT 1993-06

Keihin Carb Fuel Inlet Fitting

Stock replacement fuel inlet fitting presses into carb body. Sold Each.

- 16057 XL1983-87 (27594-76)
- 16058 BT 1981-05, XL 1988-03 (27371-76)

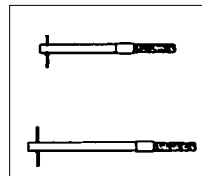
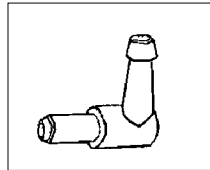

Keihin and CV Idle Screw

Screw provides easier hand adjustments.
26108

CV Main Jets (5 pack)

- | PCP | Size (mm) |
|-------|-----------------|
| 16068 | 1.60 (27152-89) |
| 16069 | 1.65 (27116-88) |
| 16070 | 1.7 (27115-88) |
| 16071 | 1.75 (27090-89) |
| 16072 | 1.80 |
| 16073 | 1.85 (27185-90) |
| 16074 | 1.90 |
| 16075 | 2.00 |



CV Slow Jets (5 pack)

- | PCP | Size (mm) |
|-------|-----------------|
| 16076 | .040 (27281-92) |
| 16077 | .042 (27171-89) |
| 16078 | .044 |
| 16079 | .045 (27170-89) |
| 16080 | .046 |
| 16081 | .048 (27165-90) |

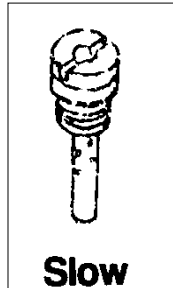

Chrome CV Carb Top

Fits XL models from 1988-06 as well as all 1990-00 BT Evo and 1999-06 Twin Cam with CV carbs.

- | PCP | Type |
|-------|-------------------|
| 21512 | Smooth (27040-88) |



Carb Related

- 29121 Fuel valve diaphragm 1997-on (61200-97)
- 14596 Carb plate o-ring BT 2000-on (11292)

CV Choke Cable Bracket

Will mount the knob assembly on top of carb for use with all air cleaners.

73733





Yost Carb Power Tube

Add performance to your S&S and Keihin carbs by atomizing incoming fuel to a fine mist with Yost's solid brass Power Tube. You get better combustion, enhanced throttle response and a smoother engine. Instructions included.

41017 All S&S B,E,G



Carb Rebuild Kit for Keihin CV

A brand new rebuild kit for all Big Twins and XL models using the CV carb. The kit includes all the necessary needles, O-rings etc... for a complete rebuild. Sold each.

Fits 1988-06 XL and 1990-06 Big Twins.

23505 Rebuild kit for all CV carbs

79824 James Keihin, CV carb rebuild kit 1988-06 27006-88

14574 Carb bowl O-ring 1988-91 (27577-88) (10 pack)

14575 Carb bowl O-ring 1992-on (27577-92) (10 pack)

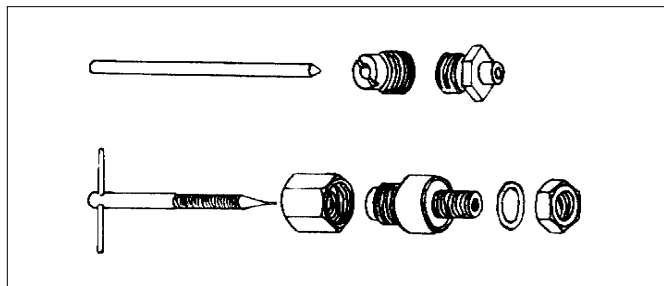

Keihin Adjustable Main Jet

Full adjustability for maximum tuning efficiency. As pictured.

16098

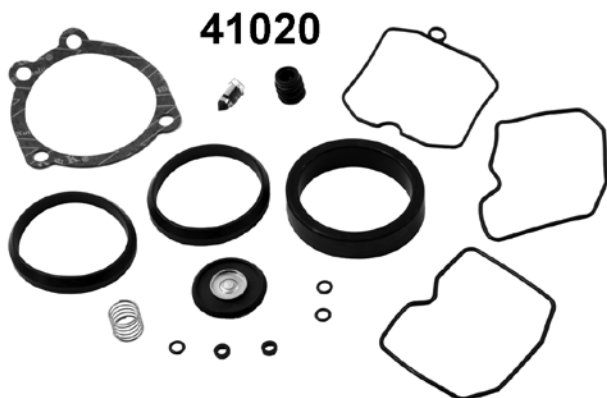

CV Carburetor Rebuild Kit

PCP	Year
41020	1988-91



Intake Manifold Flanges for Evolution® Models

These intake manifold flanges will replace the stock parts on Evolution® Sportster® models 1986-95 and Evolution® Big Twins from 1990-95. They may also be used on RevTech™, HES Performance and S&S manifolds for Evolution® models.

PCP Description

41002 Plain flanges (27009-86A, 27010-86A)

41003 Chrome flanges

14030 Seals (26995-86A) (5 pack)



"CV" Manifold "O" Ring Kit

Includes 2 of 26996-86A & 1 of 27002-89

14200 3 piece kit

Keihin



Thunder Jet Accelerator Jet & Accessories

Mounts in all Bendix-Keihin, S&S, Flowmaster, Tillotson and CV carbs; choke must be deleted for use. Works on Venturi vacuum principle as a third jet. Extra jets included.

- 16273** Thunder Jet Bendix Keihin, S&S E series
- 16274** Replacement fuel tube
- 16275** Set of 3 air bleed jets for S&S Super E & G. Includes 1 each of .135, .150, & .160
- 16276** Thunder jet for CV carb
- 16279** Jet tool, all

Adjustable Main Jet for Keihin Carb

Eliminates the chore of "hit and miss" multiple jet changes when changing pipes or air cleaners on all Keihin equipped Harley-Davidson models 1976-on. Full adjustability allows precise tuning for maximum performance with every combination of engine, pipes and air cleaner. This kit frees you from the limitation of the few fixed jet sizes available and the labor of drilling jets. Use new gaskets and seals when installing, supplied in our rebuild kit. Our installation tool correctly marks the float bowl for proper fit.

- 3820** Complete kit (shown)
- 5784** Adjustable needle only (includes 180mm jet)
- 3825** Installation tool only



Float Bowl Screws for Keihin Carburetors

If you change Keihin jets, this kit should be bolted on. Includes an allen wrench, and has a flat black finish. Fits all Keihin.

- 4747** Socket screw set 1976-89 (not CV carbs)
- 24064** Socket screw set 1989-on (CV carbs)

Keihin Low Speed Jets 1976-89 (not CV)

PCP	Size (mm) (each)
16060	.065 (27896-79)
16061	.068 (27894-78)
16063	.072 (27897-78)
16064	.075 (27382-77)
16066	.088 (27348-77)
16067	.100

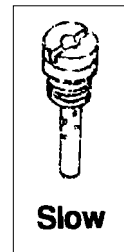

High-Flow Accelerator Pump Kit for Keihin Carburetors (not for CV) 1980-88

This kit improves the performance of stock Keihin carbs. Fits 1980-88 Big Twin and 1980-87 Sportster® models. Bolt on extra power by simply removing the float bowl, drilling one small hole in it, and installing this high performance accelerator pump body. Low and mid-range throttle response are noticeably increased. Matte finish.

- 269050** Accelerator pump kit

Keihin Main Jets for Harleys

Preston now provides Keihin main jets in four needed sizes for 1976-on Harleys.

PCP	Size (mm) (each)
3821	1.65 (27419-76)
3824	1.70 (27418-76)
3826	1.75 (27417-76)
3828	1.80 (27416-76)

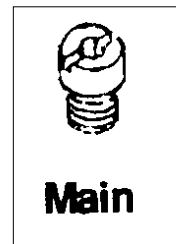

Air Cleaner Mount Gaskets

- 25096** 1977-87 (10 pack) (29058-77)
- 25186** 1988-on CV type (10 pack) (29059-88)



Slow Jet Screw Driver

- Facilitates removal of Keihin slow jets without damaging jet.
- 26135**



Carburetor Accessories



Deluxe Keihin Carb Kit

Fits BT 1976-89 and XL 1976-87 all models. Does not fit CV.

- 844** Complete Kit
- 79823** James
- 41019** Preston diaphragm pump only
- 29028** T/L Fuel valve w/clip only (27886-78A)

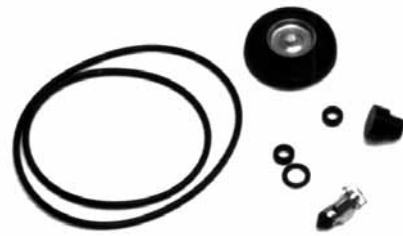

Keihin Carburetor

PCP	Item	Fits
835	Rebuild kit	1976-86 Keihin (not Flowmaster or CV) (27006-76)
14542	O-rings	Float bowl 1983-87 XL; 1984-89 BT (27324-83) (10 pk)



Vacuum Switch Assembly

PCP	Description
66408	1984-90 FXR (26557-83)
66409	1986-93 all XL, 1984-90 FXST (26558-84)
66404	1985-89 FLT (26555-84)
66405	1990 only all FLT (26555-90)
66406	1991-93 all FLT (26555-91)
66407	1994-98 all FLT, FLHT (not injected) (26555-94)
66411	1991-95 all FXST, Dyna, FXR (26566-91)
66410	1994-on XL (26558-94)
66415	1996-99 FXST (26566-96)
66416	1996-98 Dyna (26569-96)

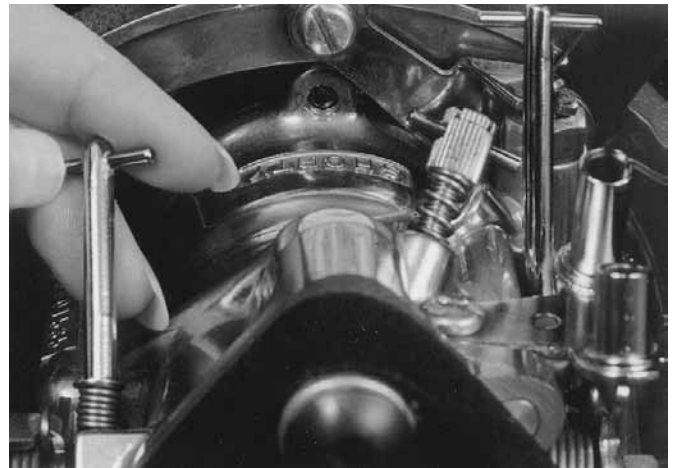

Accelerator-Idle Adjusting Screws

"T" handle design allows for easy adjustment of the idle and accelerator pump. Use the long screw for the idle and the short screw for the accelerator pump on S&S G carbs. A single idle screw is available for Bendix, Keihin/CV models.

PCP	Description
26101	S&S G
26107	Bendix
26108	Keihin & CV



Compliance Fittings

Replacement compliance fittings with extra-thick flanges to eliminate leakage at the head surface. Fit Big Twin 1984-89. Sold in pairs.

- 1326** 27008-83A, 27012-83A

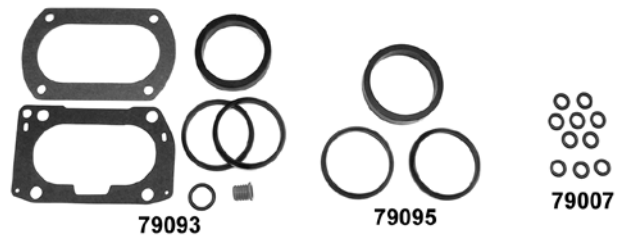

James Twin Cam Carburetor Gaskets

PCP	Year	Engine	Description
79093	1999-on	1450cc 1550cc	Intake manifold carb seal kit
79007	1999-on	1450cc 1550cc	Upper fuel injector o-ring (10pk)
79008	1999-on	1450cc 1550cc	Centre fuel injector o-ring (10pk)
79095		44mm 45mm	CV Intake manifold carb seal kit Mikuni

Carburetor Accessories

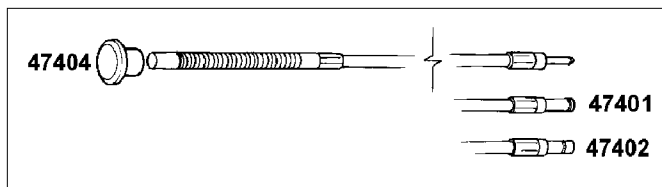

Choke Cable FLH, FXST, FLT

Cable assemblies include knob, casing, and inner wire.

PCP	Description
47401	FXST 1984-85, FXWG 1985-86 (29213-79)
47402	FXST 1986-89 (29211-86)
20014	FLT, FXST 1990-92 (29236-90)
20015	FLT, FXST 1993-on, FXR 93-94 not FI (29229-88C)
29123	FLT, FXST 1993-04, FXR 93-94 not FI (29229-88B)
47404	Chrome knob FXST 1984-89 (29214-71)
23022	Rubber grommet FXST 1982-89 (27451-82) (5 pk)
12594	Nut FLH, FXST 1984-89 (27450-82) (each)
11013	Retaining ring FXST, FLT 1979-89 (11019) (10 pk)

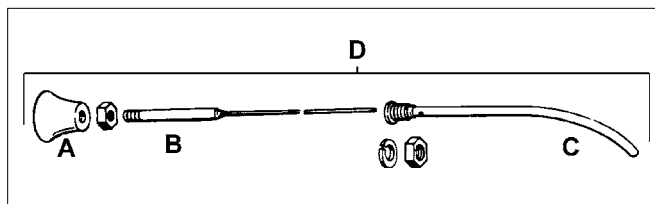

Choke Cable XL, FXR

PCP	Description
29123	(D) XL 1988-91, FXR 1993-on, Dyna 1991-05 FLT & Softail 1988-04 (29229-88C)
29118	(D) XL 1992-on (29229-88D)
20014	(D)FLT, FXST FXR 1990-92 (29236-90)



Turbulator

The turbulator turns the intake manifold into a violent mixing chamber. The heavier fuel particles are directed away from the sides of the manifold and back into the centre of the air flow. The fixed valve then tumbles the mixture resulting in higher horsepower.

PCP	Description
41000	38mm 2 bolt fits Keihin and Bendix
41004	40mm 2 bolt S&S Super B and E, and flat slide Mikuni
41009	CV all Keihin

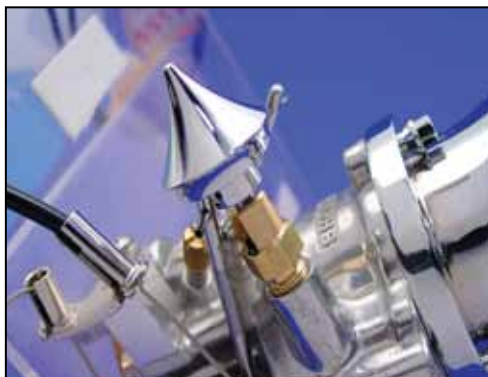

S&S Enricher

S&S Super E and G features 3 position with pike knob.
73731

Air Cleaner Screws

1/4 x 20 S&S Style screws.
4736 (3pk)



Quick Change Float Bowl Screws

For S&S Super B & D models to facilitate jet changes by easy bowl removal. Includes 4 knurled screws with large slots in satin finish.

41001 Set of four

Cable Blocks

Used to attach inner cable to carburetor. Complete with screw and cotter key. Replaces OEM 27450-36, 27719-67 and 27716-67.

1503 Sold Each



Sifton Idle Speed Knob for HSR 42/45

73535



Complete Choke Cable Assembly BT 1988-04

Includes cable, cable guide, sealing cap, starter valve, starter cap and enrichment spring.

21812 Imported
29123 T/L

Manifolds & Adaptors



Stock Intake Manifolds

Cast alloy. USA made.

PCP Application

41032 Evo 1340 1990-on spigot type (27019-89A)

41033 XL 1988-on spigot type (27004-88A)

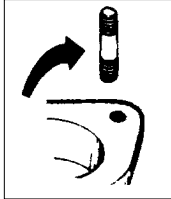

Carb Mount Studs

PCP	Size	Application
10842	5/16 x 1-3/4	1978-85 (29253-78) (pair)
10876	5/16 x 1-1/4	1978-89 (29254-78)



Manifold Repair Rings

Adapter rings for repairing the lips on the head and intake manifold. They may also be used in customizing, to adapt early-type manifolds to late-type heads and vice-versa. The stroker rings can turn a stock manifold into a stroker manifold for .200" taller cylinders or stroker plates. Adapter and stoker rings are available in pairs.

3273 Adaptor rings

3280 Stroker rings



Rubber Flange Adaptors (not for HS40's)

1968 36-38mm

1969 40-44mm



2090

2091

Carb Manifold Adaptors

Fit with our #1303 Manifolds.

2090 36mm to 38mm stepped manifold adaptor

2091 40-44mm straight through manifold adaptor



CV Carb Adapter

Adapts the HSR-42 Mikuni or CV carb to a 2-bolt manifold.

41007 2 Bolt early style



Manifold Spacer 1971-on

Fits 1971 to present. Includes 2 gaskets.

2471 Manifold spacer 3/8" (29250-78)

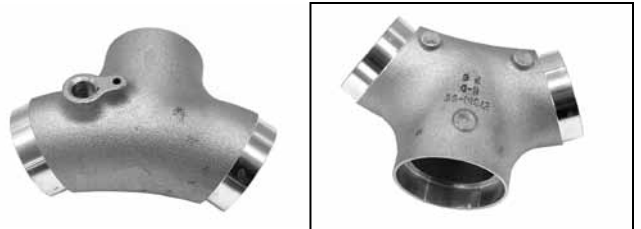

Stock Intake Manifolds

Are cast alloy as original to fit 1999-on TC88.

41034 27613-99

Air Cleaners



7" Nostalgic Style Air Cleaner

Air cleaner with centre screw available with cover to fit Bendix, Tillotson, Keihin and CV carbs. Includes breather tube, backing plate and element. Approximately 3" thick.

PCP	Description
45340	CV 1989-92 BT 1340
45342	CV 1993-on BT 1340
45343	Smooth air cleaner cover only
45344	V-Logo air cleaner cover only
6670	Foam element



Chrome S&S Air Cleaner Kits for Stock Carbs

170105	Buell, CV 1994-02
170108	BT 1984-89, XL 1986-87 with Butterfly
170100	BT CV 1993-on and XL CV 1991-03
170101	TC 1999-on



8" Chrome Nostalgic Air Cleaner

Air cleaner is available for BT 1990-99 as a complete assembly or as a replacement cover only for stock backing plate. Cover features an embossed design and centre screw mounting.

45010	CV (B) BT 1990-99
-------	-------------------

Air Cleaner Covers Only

PCP	Carb	Description
45249	CV (B)	Cover only BT 1990-99

Note: For 1993-on models order breather kit #27170, and for pre-1993 models use bracket #4374



Colony Polished Chrome Intake Manifold Mounting Kit

9930	BT L1982-89
9931	BT 1990-94, XL 1988-94
9932	BT 1995-on, XL 1995-on



Eagle Spirit Round Air Cleaner Insert

Fits 1999-on TC88 models.

59156	Chrome
59157	Gold inlay



Intake Manifold O-Rings & Seals

PCP	Description
14034	L1978-85 Flat seal (27062-78) (10 pk)
14400	As Above, red silicone (10 pk)
14030	1986-on 883-1200 (26995-86A) (5 pk)
14102	1989-on BT-XL (27002-89) (each)

James Intake Manifold Seal

79510	1986-98 (26995-97-X)
-------	----------------------



Air Cleaners



V-Charger Chrome Air Cleaner and Filter

Chrome cleaner includes filter for CV models.

PCP Style
21798 Flame



59038



45354

New Era Air Cleaners Assembly Kit

Kit includes complete chrome air cleaner, mounting bracket, and breather kit.

45353 BT 1993-99
45354 XL 1991-on



59723

V-Charger Chrome Air Cleaner

Chrome cleaner features air scoop with built-in chrome screen and filter. Kits include brackets and/or breather kits as required.

PCP	Application
59034	CV 2000-on TC88
59035	CV 1993-99 BT
59036	CV 1990-92 BT
59723	S&S 1992-99 BT
59037	Keihin 1984-89 BT
59038	CV 1991-on XL
59039	CV 1988-90 XL
77745	Filter



Ribbed Teardrop Air Cleaner

Chromed aluminum cover features diecast backing plate and built-in venturi for increased air flow.

PCP Description
45144 Fits CV carbs XL 1988-on, BT 1990-on EVO



S&S Aircleaner Cover

Screws, chrome plated.
4736 Set of 3



Tear Drop Air Cleaner Assembly

Tear drop style die cast air cleaner assembly. Fits all the Bolt Carbs, Keihin, (not CV), Tillotson, & S&S units (not E or G).

1229 Air cleaner, complete (29205-87T)

Air Cleaners

29433



S/E Stage I EFI Air Cleaner Kits

Use these kits to provide more power to your Twin Cam EFI models. Kits include air cleaner, breather, and all required hardware. Please note recalibration is required for proper installation, and will allow engine to rev to 6200RPM.

PCP Application

- 29433** 2002-07 EFI Touring models and 2001-07 Softail, 2004-on EFI Dyna with accessory air cleaner covers and 2008-on Softails and Dynas with accessory air cleaner cover (29773-02B)
- 29432** 1999-01 EFI Touring models (29489-99C)



Sportster S/E Air Cleaner Kit 1988-03

29437 29066-03



Stage II High Flow Air Cleaner Kit

Complete breather kit for carbureted BT TC-88 models. Fits 99-05-on Dyna equipped with stock CV carb, 42mm flatside carb or 44mm CV carb and accessory air cleaner covers.

29411 29440-99D



Screamin Eagle CV Air Cleaner Kit BT 1993-99

29431 29543-99B



Chrome Air Cleaner Cover for Twin Cam 88

Cover features a concave centre with nostalgic bar and shield emblem. Does not work with Screamin' Eagle high flow filters.

29415 All TC88 engines w/out fuel injection (29550-99)



8" EVO Type Air Cleaners

Includes chrome cover, foam element and backing plate.

Order brackets separately.

PCP Description

- 45325** Keihin
45326 CV 1989-on
6670 Foam element

Air Cleaners

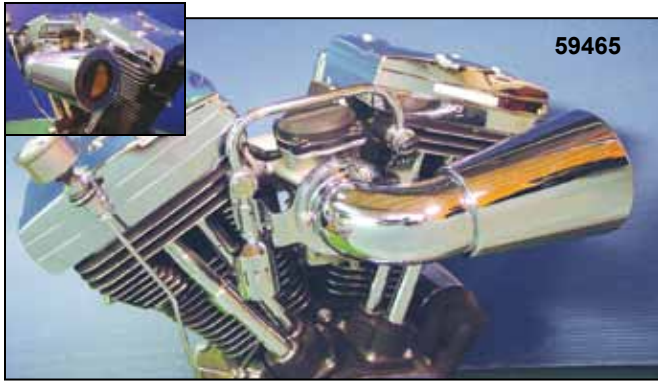

Air Cleaner Breather and Bracket

Includes billet bracket with breather bolts and tapered filter element with chrome 90 degree intake tube to face forward on CV carbs. To face forward or upward on S&S models, order adaptor plate PCP# 41038 for use with PCP# 59417 spike cleaner.

PCP	Item	Style
59417	Spike	Forward
59465	Funnel	Forward
41006	S&S	Forward adapter
41038	CV	Vertical adapter
59467	Spike filter only	
21698	Funnel filter only	
Air Cleaner Bracket Only		
59720	Spike	
59721	Funnel	



Panzer Air Cone for S&S E Carbs

Fits S&S E carbs and is fully rotational when used with the Sifton integral breather bracket #21866, sold separately.

PCP	Item	Type
21800	Air cone	Spike
21867	Air cone	Holes
21866	Bracket	
21869	Filter only	



Adapter Plate

Will rotate #59417 or #59465 air cleaners to a vertical position on CV carbs.

41038



Adapter Plate

Allows installation of CV air cleaner to S&S Super E carbs and horizontal or vertical mounting of #59417 or #59465 air cleaners.

41006



CV Air Cleaner Cone Systems

Features cone and integral breather mount bracket for forward mounting.

PCP	Carb	Type
21882	S&S E	With breather tube
21883	CV	Integral



Air Cleaners



TC Ram Charger

Available for all Delphi EFI equipped 2001-on FXST, 2002-on FLH/Touring and 2004-on Dyna Glide.

21769



59961

Velo Dish Air Cleaners

Features chrome dish and full flow filter with integral backing plate and hardware. Fits 1992-on FXST carb or FI models and 2002-on FLT FI models.

Cleaner	Size	Filter
59961	6"	77777
59962	8"	77778

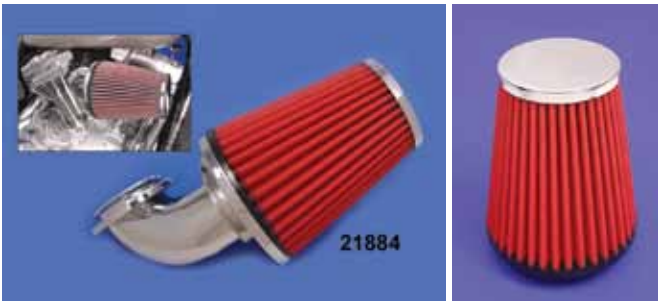

21884

Cycovator Taper Forward Mount A/C Kit

PCP Item

21884 CV-EFI for FLT 1993-07 (not 1995-01 EFI); FXST, FLST, FXD 1993-07, FXR 1993-94

21886 Filter only



Turbo-Fan Velocity Stack

Includes inverted cone filter installed. Turbo fan turns on precision ball bearings up to 10000 RPM.

21813



Turbo Funnel

Will mount on CV carb bolt pattern in a forward horizontal position. Order adapter plate #41038 to place in upright vertical position.

21643

Air Cleaners



Chrome Teardrop Big Twin Air Cleaner Kit

Includes die cast backing plate, filter, teardrop chrome cover, breather, canister set and bolts for 1992-on Evo and 1999-on TC88 models.

59256 CV models



Chrome Oval Air Cleaner Insert 2000-on TC

PCP Application
45369 Smooth insert



Cycovator Forward Mount Air Cleaner

Fits 2002-on EFI BT models.

PCP Item
21884 Kit with "Taper" style cleaner
21804 Tapered filter
21784 8" Air cleaner



Chrome Flame Tear Drop Air Cleaner Kits

Kit includes a chrome air cleaner assembly, chrome mount bracket, breather kit with a black hose and a breather unit.

PCP Application
59031 1992-99 BT
59032 2000-on TC88
59033 1991-on XL



Sifton Air Cleaner Kits

Includes a hi-flow "Cycovator" element with an integral metal backing plate for a direct bolt on application for carburetor and electronic fuel injected models. Reuse of some original hardware required.

PCP Item Models
59132 2008-on Touring
59136 1993-07 CV-Delphi EFI Big Twin

Air Cleaners



Velo High Flow Air Cleaner Backing Plate Kit
Sifton kit includes chrome one piece alloy backing plate, washable element, accepts 8" round covers with 52" of surface measuring 7" x 2-3/4" deep, stainless steel breather kit with fittings and chrome breather and necessary hardware to mount 1992-on BT models. Cover not included.
59407



Velco High Flow Air Cleaner Baking Plate Kit By Sifton
Includes chrome one piece alloy backing plate, washable element, accepts 8" round covers with 52" of surface measuring 7" x 2-3/4" deep, stainless steel breather kit with fittings and chrome breather filter and necessary hardware to mount 1992-on Big Twins Evo and TC88 models. Covers not included.
59409 CV
59416 S&S Super "E" models



Velo High Flow Air Cleaner Assembly
Includes one piece alloy back plate. Unit includes element, breather kit and all mount hardware for 1992-on BT and TC-88 carbureted models. Also fits TC-88 EFI 2002-on.

PCP	Application	Description
45356	1992-on carb	With 7" round cover
45357	1992-on carb	With oval cover
77777	Filter only	



T/L Chrome Billet Air Cleaner Insert 1994-99
63003 29065-94



Siren Air Cleaner Assemblies
Includes cover, backing plate and mount hardware for Big Twin 1992-on.
PCP **Year**
59163 1992-99
59164 2000-up

Air Cleaners



Sifton Air Power

Includes die cast backing plate, filter and breather canisters. Hardware included allows installation on Evo 1992-99 and TC88 models with carburetor. Order cover separately as listed below. Breather bolts also available separately.

- 59221** Air cleaner kit
- 73584** 1992-99 Bolt set
- 73585** 2000-on Bolt set



Velo High Flow Air Cleaner Backing Plate Kit

Kit includes a one piece alloy backing plate, a washable tapered element, stainless steel breather kit with fittings and chrome breather filter and necessary hardware to mount 1992-on BT Evo and TC88 models. Cover not included.

- 59030** Carb model
- 59406** EFI model



XL Velo Air Cleaner Assembly 1991-on

Bolts on to 1991-on XL models and includes breather bolts. **59820**



Early Style Carb Breather Snoots

Features chrome cover without filter. Bendix Keihin and CV have 3 bolt pattern. CV requires the use of #27232 for 2000-on BT or #27224 for 1993-99 BT.

- | PCP | Application |
|--------------|---------------|
| 59558 | Bendix-Keihin |
| 59559 | CV |



Air Cleaners

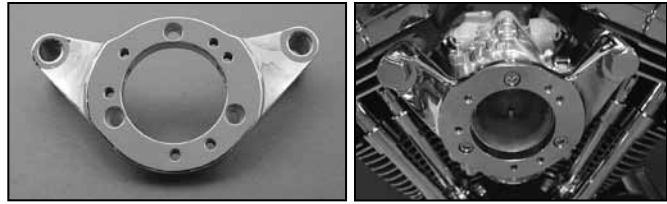

Skull Air Cleaner

PCP	Application
21737	1999-07 Twin Cam 88 CV and EFI
21861	1993-99 Evo BT



Chrome Billet Carburetor Bracket Kits

Features integral breather passage to air intake. Kits include breather bolts and hardware. For use on 1993-07 Evolution, TC-88 CV and Electronic Fuel Injection only. Allows mounting of CV or S&S pattern air cleaners or velocity stacks to model/carburetor types as noted.

Big Twin CV

PCP	Model/Carburetor Type	Note
59466	Big Twin CV	CV/S&S
59463	CV 1992-94 and EFI 2001-on	

Big Twin S&S "E"

21866	Big Twin S&S E	S&S
59464	Big Twin S&S "E"	CV
59468	Big Twin S&S "E"	S&S



Velo Air Cleaner Assembly

Includes billet bushing plate, tapered high flow filter element and all fittings required to fit Evo and Twin Cam 88 1992-on. 59408



Billet Carb Support

For S&S super E installations. Order banjo bolts and brackets separately for Evo or TC. Bracket is only drilled for S&S style carb. There are no holes for CV air cleaner.

59478

Air Cleaner



Air Cleaner Inserts

Round inserts fit the recessed are of round center screw type units.

PCP	Description
45130	7" Chrome (29400-90T)
45230	7" Gold inlay (29401-90T)
45131	8" Evo chrome (29289-89T)



Billet Air Cleaner Mount Set

Will mount air cleaners with flat backing plates to EV and TC-88 models. Offset billet mounts feature built-in breather passage that feeds inside air cleaner housing. Brackets can be rotated to proper position, then by drilling the back plate. Threaded breather nipples will fasten back plate to brackets.

PCP	Application
73655	1991-99 Evo
73656	2000-on TC-88



Chrome Round Cover for CV

Fits 1993-on FXST.
21789



Chrome Maltese Cross Carb Cover

Includes backing plate without filter. Available as kit or carb cover and backing plate only. Kits include brackets and or breather kits as required to fit stock original carb. Centre portion of cross has a matte chrome finish.

PCP	Application
59421	1993-99 BT

Air Cleaner Cover only

PCP	Fits
59427	S&S Super E

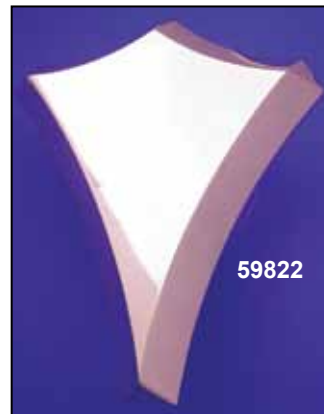

Chrome Billet Air Cleaner

Mount kits sold separately.

PCP	Style	Carb
59822	Diamond	CV
21665	Skull	CV
21666	Diamond	S&S
59463	Bracket	Evo and Twin Cam

Air Cleaner



Velo-dome Velocity Stack

Domed velocity stack fits Super E models.

- | PCP | Item |
|-------|---|
| 21757 | Stack with cover |
| 59478 | Bracket kit with integral breather passages |



Billet Velocity Stack-S&S Super E

Fits #59464 bracket. Stack includes inverted cone filter element.

- | PCP | Item |
|-------|--------------------|
| 21790 | Kit |
| 59547 | Stack |
| 59464 | Bracket |
| 73617 | Replacement filter |

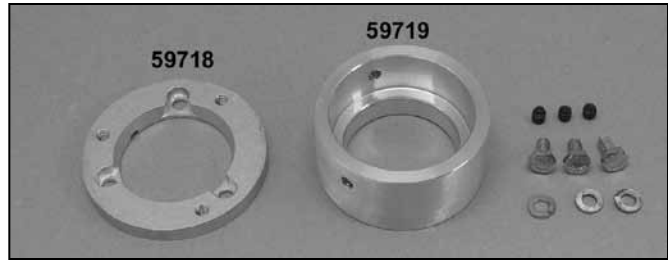

Mikuni Air Cleaner Adaptor Plate 42 & 45mm

Will adapt any CV style, 3-bolt air cleaner to the Mikuni or CV Keihin as noted.

- | PCP | Application |
|-------|----------------------|
| 59717 | 42mm and 45mm Mikuni |
| 41006 | CV to S&S E and G |
| 59718 | 38mm CV to Keihin |
| 59719 | 38mm Mikuni |



Diamond Billet Air Cleaner

Fits CV models.

21799



Billet Scoop Air Cleaner

Includes filter and mount brackets. Fits 1991-on BT with carburetor.

- | PCP | Style |
|-------|--------|
| 59725 | Smooth |

Air Cleaners

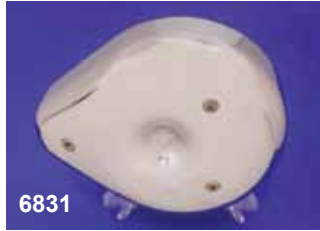

6831



6832

883-1200 & BT CV 1990-on Air Cleaner

Chrome die cast tear drop design with backing plate to fit the constant velocity carbs on 1988-on XL and BT 1990-on. Includes element.

- 6831 Smooth tear drop
- 6832 "Live To Ride" chromed (29286-88T)
- 45240 "Live To Ride" gold inlay

Bracket for CV to custom air cleaner

- 27171 1991-03 XL
- 27170 1993-on BT (not FXD)
- 4374 1985-90 BT



27171



27170

Bracket for CV to Custom Air Cleaner

- PCP Fit
- 27171 1991-03 XL
- 27170 1993-on BT (not FXD)
- 4374 1985-90 BT



4374



45112



6592

Replacement Parts for Tear Drop Air Cleaners

- | PCP | Description |
|-------|-----------------------------|
| 45277 | Polished cover |
| 45279 | Chrome cover |
| 45233 | Bendix-Keihin backing plate |
| 45234 | CV backing plate |
| 4736 | Chrome screw set (3 pack) |
| 6670 | Uni-filter element |



"Live To Ride" Air Cleaner Assembly

This high-quality air cleaner assembly features a chrome plated die-cast aluminum cover and a built-in venturi which delivers improved performance. Includes the backing plate, screws and a foam filter element.

- 6594 Fits S&S carbs (not "E's") as well as Tillotson, Bendix (Zenith) and Keihin (except CV) (29204-87T)
- 45239 As above with gold overlay
- 6670 UniFilter foam air filter element



Flame Tear Drop Air Cleaner

Comes complete with chrome cover, foam element and backing plate. Brackets sold separately. XL 1991-99 and BT 1993-on bracket kits include breather line.

- 45190 Bendix-Keihin

6590



6591



Eagle Spirit Collection

Heavy die-cast chrome plated pieces, emblazoned with an eagle design. Air cleaners are die casted with 3 bolt mounting and venturi style backing plates for Keihin and Bendix use. Points cover fits 1970-on FX-FL models with horizontal screws.

- 6590 New Era air cleaner (not CV carbs)
- 6591 Centre screw cleaner (not CV carbs)
- 45112 Points cover
- 6592 Derby cover, 3 Bolt

Air Cleaner



Chrome Teardrop Air Cleaner Assembly

Fits S&S E models. Filter and back plate included.

59947 Assembly 1992-on Evo, Twin Cam

77777 Filter only



77101



4634

Crankcase Breather Assembly

Mount your breather in plain view instead of hiding it behind your engine or transmission case. Comes complete with a one-piece filter molded to a light weight chrome end cap, a chrome zinc die-cast mounting base with 5/16" inlet and a hose clamp. The hose clamp holds the filter to the base when the vent hose is installed.

77101 Complete assembly

4634 Replacement filter ONLY (no chrome)

2" diameter x 1/2" height



Chrome Flow Swept Air Cleaner Assembly

Fits 1993-on EV and TC models. Bracket kit sold separately.

59948 Assembly

59949 Bracket kit

77777 Filter only

Air Cleaners



Chrome Air Cleaner Brackets, for Evolution

Mounts to boss on engine heads to support custom air cleaners.

PCP	Model	Years
27022	1340cc (inlet 2")	1984-89 (mount holes 6" c/c)
27024	1340cc (inlet 2-1/4")	1990-91 CV (as above)
59720		1984-99 with choke bracket
59721		1993-on (for use w/breather kit)
27023	883-1100-1200XL	1985-87 (mount holes 5" c/c)
27025	883-1100-1200XL	1988-90 CV (as above)

Custom Air Cleaner Breather Kit BT 1992

Necessary when using custom air cleaners or carbs.

27082 29304-92



Note: These support brackets will not work with #45336 series round air cleaners or #6591 air cleaners



Chrome Air Cleaner Support Brackets

For installing custom round or teardrop air cleaners on BT 1984-92 and XL 1985-90.

4374 29208-87T

Air Cleaner Mount Gaskets (10 pack)

James	PCP	Description
	25096	1977-89 (29058-77)
79190	25186	1988-on CV type (29059-88)
79519	-	1995-on Injector type (5 pk)
79546	-	1995-on Carb (29062-95B)



Carb Vent Fitting

1/8" Chrome, steel nipple for air cleaner backing plates. Sold in 5 packs.

PCP	Hose	Angle
10502	5/16"	90 degree



1993-on EVO BT Breather Kit

For custom air cleaners to motors with the internal breathing system.

PCP	Description
27172	BT 1993-on w/round cleaner (not FXD) (29310-93)
27171	XL 1991-03 w/teardrop air cleaner (29281-91T)
27170	BT 1993-on w/teardrop (not FXD) (29283-92T)
16534	Banjo bolts only Evo 1992-99 (pair)
16538	Banjo bolts only TC88 99-on (pair)



Extended Breather Bolts

Allows the mounting of air cleaner to breather bolt stand.

PCP	Application
73657	TC-88
73658	Evo, XL

Carb Breathers



Sifton Vent Cannister

Includes line and clamps.

59160



Sifton Dual Vent Kit

Includes 2 vent cannisters, fittings and banjo bolts for Evo and TC88 models.

59159



Chrome Billet Crankcase Breather

Features 1/8" NPT fittings.

77106



Breather Bolt and Banjo Kit BT

Includes bolts for 1993-02, XL 1991-02 applications and 2 banjo bolts to accept 5/16" hose.

PCP Description

- 73501** Without tee
- 73502** With tee
- 73503** Evo nylon washers
- 73504** TC88 nylon washers



Sifton Braided Hose Crankcase Breather Kit

Kit features a 3/8" I.D. braided stainless steel hose, breather filter with mounting stud, and hardware. Air cleaner and carb support bracket must be purchased separately. Fits 1993-2001 BT custom applications only.

PCP Description

- 77421** Kit
- 77105** Breather
- 73500** Bolt kit

Sifton Breather Canister

Features enclosed breather filter and tube for attaching to breather cross over lines, which is held in place by set screws. Bottom cover is removable for cleaning.

PCP Description

- 59195** Canister
- 59196** Breather tube kit
- 59197** Tube only



Yost Pro Mod Breather Kits

Designed to be modular, this kit allows for a custom look with an extra 2 ponies. Kits can be used with an air filter and stock cover, or without an air filter by using the screen provided. Machined from solid 6061 T6 billet aluminum with an unique internal breather design (no more hoses). Includes installation hardware.

PCP Item

- 21767** Kit 1999-on TC, 2002-on Delphi FI
- 21768** Kit 1993-99 Evo BT

Carb Breathers



Sifton Dual Breather Kit

Includes 2 canisters, banjo tubes and bolts for Evo and TC88 applications.

59158



Sifton Dual Breather Kit

Kit includes 2 breathers with chrome ends and banjo tubes with hardware for Evo and TC88.

59228



Sifton Chrome Dual Canister Breather Kit

Fits Evo and Twin Cam models.

59244



Chrome Billet Canister Set

Includes bolts for Evo and TC88 applications.

59438



27224

Crankcase Breather and Bracket Kit

Fits CV carbs to allow use of aftermarket air cleaners on models with cylinder head/crankcase breather systems. Air cleaner must be ordered separately.

PCP	Description
27223	XL 1991-03
27224	BT 1993-99
27232	BT TC88 2000-on
77027	Filter for above



16534

BT Breather Bolts 1992-on

PCP	Application	Type
16534	1992-99 Evo	Hex
73610	1999-on TC	Hex
16538	1999-on TC	Nipple



73610



16253

Evo Breather Kit

For use with custom air cleaner or carb on BT 1993-on and XL 1991-on. Accepts 3/8" hose.

16253	4 pc kit
16534	Bolts only Evo 1992-99
16538	Bolts only TC88 1999-on



16534

Cable Clamps



2 Piece Chrome Dual Throttle Cable Separator

PCP	Holes	Handler Bar Size
73508	2	1"
73509	1	1"
73510	2	1-1/4"
73511	2	1"

2 Piece Chrome Cable Clamps.

Secures cables or wires to frame and forks. Sold each.

PCP	Size	# Holes	Type
27525	1"	1	Clutch
27526	1"	2	Throttle
27511	1-1/8"	1	
27512	1-1/4"	1	Throttle
73748	1-1/4"	2	Throttle
73749	1-1/4"	1	Clutch
27513	35mm	1	Clutch
27515	39mm	1	Speedo
73667	41mm	1	Speedo
73750	49mm	1	Clutch



Chrome Cable Clamps

Unique two piece design allows easy installation. Swivel head design allows more natural cable routing without excessive bending. Rubber sleeves protect painted surfaces and cable housing. 1" clamps fit handlebars and aftermarket frames.

PCP	Size	Holes	Type
44119	1-1/4" - 1-1/2"	Single	Throttle/clutch
44120	1-1/4" - 1-1/2"	Dual	Throttle/clutch
44121	1" - 1-1/8"	Single	Throttle/clutch
44122	1" - 1-1/8"	Dual	Throttle/clutch
44123	7mm - 9mm	Single	Cable holder
44124	7mm - 9mm	Dual	Cable holder



Chrome Billet Cable Clamps-Sold Each.

PCP	Size	Application
73670	1"	Throttle cable, single
73672	1"	Clutch cable
73673	1-1/8"	Clutch cable
73674	41mm	Clutch cable
73675		Speedo cable to fender

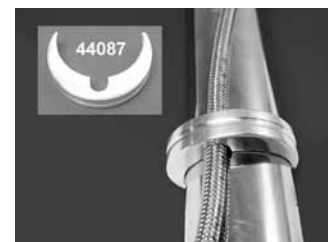
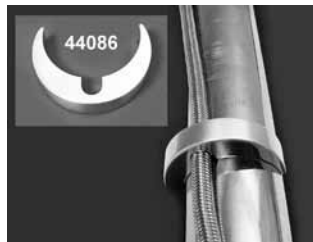

41mm Push On Fork Tube Clamps

Use to secure speedo cables and brake lines. Sold Each.

PCP	Style
44086	Smooth
44087	Groove

Throttle Cables



Throttle by Wire +4" Extension Harness Kit

For the right side only and has 6 wires total. Does not have cruise and fits the Molex connector. Fits FLT 2008-on.

21856



Throttle by Wire Extension Kits

"TBW" Extension harness will plug into the existing 6 position Molex connector. These wire extensions will not cause interference to motorcycle's computer when installing taller handlebars. Kits includes left and right sides for 14 wires total.

PCP	Extension
21872	+8"
21873	+16"



Electronic Throttle Assembly

With gear and wire for 2008-on Touring models with "TBW" throttle by wire.

21871

Throttle by Wire Extension Harness Kit

Throttle by wire +12" extension harness kit is for the right side only and has 6 wires total, without cruise. This harness fits the Molex Connector. Order switch housing kit separately left and right side. Fits FLT 2008-on.

21903

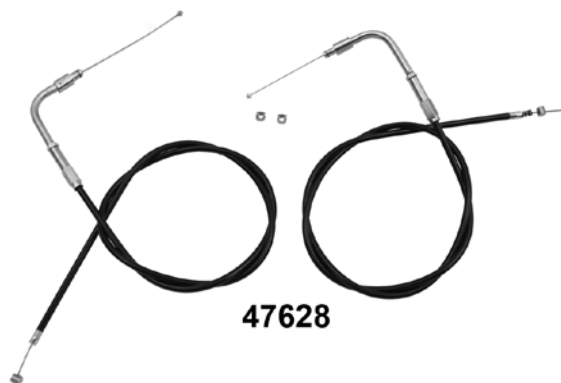

M&M Black Throttle and Idle Cable Set.

Black throttle and idle cable set with elbow fitting.

PCP	Casing		Fitment
	Length	Elbow	
47624	36.81"	45	FLH 1981-84, FX 1981-84, FXST 1984-89, FLST 1986-1989 (stock length)
47625	44.81"	45	+8", As above
47626	34.92"	90	FXST, FLST, FXD 1990-95
47627	42.92"	90	+8", As above
47628	34.84"	90	FXST, FLST, FXD 1996-on
47629	42.84"	90	+8", As above



M&M Stainless Steel Throttle and Idle Cable Set.

Stainless steel throttle and idle cables are clear coated.

PCP	Casing		Fitment
	Length		
47605	33.66"		XL 883/C, 1200S, 1200C 1999-03 stock length (56564-02)



Throttle Cables



Barnett Throttle Cables

All Barnett throttle cables are made with black PVC coated stock diameter nylon lined casing with 3/64" extra flexible (7 x 7 strand) inner cable for extra long life. All cable fittings and elbows are bright nickle finish.

Barnett Misc. Carb Cables

Part	Size	Description
2234		For early type Mikuni carb conversion 38-44mm , universal, not for HS40 and newer
47000	41"	Throttle cable Mikuni HS 40 kits thru 1995 130 degree elbow
47002	41"	Idle cable, as above
47005	41"	Throttle cable Mikuni HS 40 kits 1996-on 90 degree elbow
47006	41"	Idle cable, as above
47007	36"	Throttle cable Mikuni HS-42/45 1981-95 130 degree elbow
47009	36"	Throttle cable Mikuni HS-42/45 1996-on 90 degree elbow
47011	38"	Throttle cable S&S Super E,G 1981-95 130 degree elbows
47832		S.S. as above
47012	38"	Idle cable, as above
47833		S.S. as above
47013	38"	Throttle cable S&S Super E,G 1996-on w/90 degree elbow
47834		S.S. as above
47014	38"	Idle cable, as above
47835		S.S. as above
7424	35"	Throttle cable S&S (not super E,G), SU, Bendix 1981-95, 130 degree elbow
7426	35"	Idle cable, as above
7425	41"	Throttle cable, as above
7427	41"	Idle cable, as above

Barnett Throttle Cables For Mikuni HS40 Kits Mikuni Thru 44mm (Not HS 40/42/45)

- 47000 Throttle cable (pull) 41" 130 degree 1982-95
- 47001 Throttle cable +6" (pull) 130 degree 1982-95 (47" outer)
- 47002 Idle cable (push) 41" 130 degree to 1982-95
- 47003 Idle cable +6" (push) (47" outer)
- 47004 Adapts 1981-95 stock throttles to Mikuni carbs thru 44mm (not HS 40/42/45)

Chrome Throttle Clamps

Clamps feature smooth design, upper and lower pieces with screws for single or dual cable applications.

PCP	Application
73506	Single
73507	Dual



Chrome Throttle Housing

Custom design for single cable operation.

73663



Chrome Cable Wrap 60" Long

Classic 50's style dresser trim item.

45196 Small diameter 3/16"



FLT 1984-89 Carb Cables Imported

- 47420 Throttle (56327-81B)
- 47421 Idle (56328-81B)

XL Throttle or Idle Cable Assemblies

- | Black | Description |
|-------|------------------------|
| 5701 | 1986-87 Stock throttle |
| 5702 | As above stock idle |

Throttle Cables

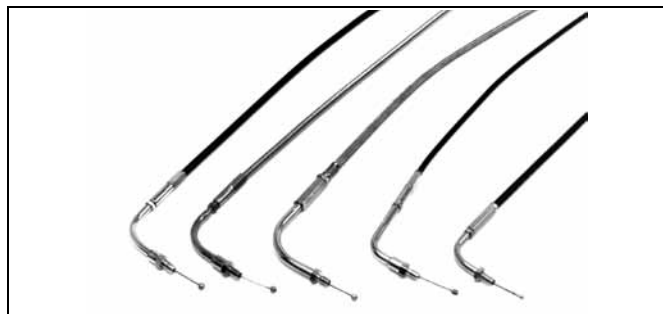

Big Twin Throttle or Idle Cable Assemblies.

Available in black vinyl or braided stainless steel (not clear coated) with correct end fitting for each application. Also available in overstock length, as noted.

Stainless	Black	Description (Imported)
5705	2237	1981-89 FX, FLH, FXST, FLST Stock throttle cable
-	47426	As above +12"
5704	2238	As above stock idle
-	47427	As above +12"
	3651	1983-87 FXRT, FXLR, FXRSE Stock throttle cable
	3655	As above stock idle cable



M&M Clear Coated Stainless Braided Cables

Cables for throttle and idle applications.

PCP	Size	Application	Elbow Degree
59869	42"	1996-on S&S	
21847	43.5"	1996-on S&S	
59605	50"	1996-on S&S	
59603	38"	1982-95 S&S	
59604	50"	1982-95 S&S	
59600	Stock	1996-on FXST, FLST, FXD	
59870	+8"	1996-on FXST, FLST, FXD	
59601	Stock	1990-95 FXST, FLST, FXR	
21848	+8"	1990-95 FXST, FLST, FXR	90
59602	Stock	1981-89 FX, FLST, FLH	
21834	Stock	1998-01 FLTR1 1996-01 FLHTCUI	
21835	Stock	2002-on FLHRC, FLHR/I	
47605	Stock	1999-03 XL 1200C, 883/C, 1200S	

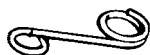

Control Cable Guide Hook

Replaces OEM 45092-66. Stock on 1966-89 FL's but has many universal applications.

3980 Control hooks (5 pk)

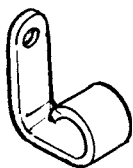

Cable Routing "L" Bracket

Chrome bracket used for 1/2" O.D., on brake, clutch cables and hoses. 1/4" mounting hole.

16200 Sold each

Inner Throttle Sleeve

Custom design allows pull action or throttle cable for use with billet grips.

59730



1. Cut 2-3/8" off end of handlebar. Remove end of throttle handle that would attach to throttle cables.
2. Mark handlebar for inner throttle sleeve. Drill a hole for the set screw that will hold throttle on the handlebar.
3. Remove set screw from the outer sleeve of spiral. Slide grip on and mark the end of grip on the handlebar. Measure from this mark back to set screw in outer sleeve. This measurement will be used to mark and drill the throttle grip. Once drilled, install grip. Use a small amount of Loctite on set screw for final installation.



Heat Shrink Tubing for Braided Cables

Use clear heat shrink tubing on all braided stainless steel cables to prevent scratching of chromed or painted surfaces. Kit contains 4-16" long heat shrink tubes to cover 2 throttle cables, 1 clutch and 1 speedo cable.

PCP	Application
28713	Cable sleeve kit
28714	3/8" x 10' roll
28715	1/2" x 10' roll
28716	3/4" x 10' roll



Radii Roller Bearing Throttle Sleeve

Features precision ground bearing for smooth operation by reducing drag at end point. Requires handlebar modification. Accepts stock type nylon throttle tube or billet grips for either single or dual cable application.

59731

Barnett Cables

Barnett's smooth working, long lasting cables are virtually indestructible and are made from the finest components available. Casings are constructed from hard drawn spring wire and all fittings, ferrules and adjusters are machined in house from brass, aluminum and stainless steel to stringent specifications. All Barnett throttle cables are made with black PVC coated stock diameter nylon lined casings with 3/64" extra (7x7 strand) inner cable for extra long life. All cable fittings and elbows have a bright nickel finish. **All stainless cables have an anti-abrasive clear coat to protect paint and polished metal.**

THROTTLE CABLES

OEM	Black Vinyl		Stainless Steel	
	STD	+6"	STD	+8"
56306-88	47226	47227		
56306-90	47230	47231		
56306-96	47254			
56308-86	47208	47209		
56308-88	47212	47213	47800	47801
56308-96	47240		47804	47805
56313-76	47202	47203 +8"		
56314-78	47200			
56320-77	47202			
56324-81C	47204	47205 +8"	47808	47809
56327-81B	47216		47812	47813
56327-90	47220		47824	47825
56327-96	47262		47828	47829
56336-83	47224			
56343-88	47238			
56343-90	47234	47235 +8"	47816	47817
56343-96	47249	47250 +8"	47820	47821
56357-02	47304			
56375-96	47262		47828	47829
56376-94	47220			
56379-96	47246			
56400-96	47258			
56357-96	47248			

IDLE CABLES

OEM	Black Vinyl		Stainless Steel	
	STD	+6"	STD	+8
56305-88	47228	47229		
56305-90	47232	47233		
56305-96	47256			
56309-86	47210	47211		
56309-88	47214	47215	47802	47803
56309-96	47242		47806	47807
56323-81C	47206	47207 +8"	47810	47811
56328-81B	47218		47814	47815
56328-90	47222		47826	47827
56328-96	47264		47830	47831
56337-83	47225			
56342-88	47239			
56342-90	47236	47237 +8"	47818	47819
56342-96	47251	47252 +8"	47822	47823
56358-96	47247			
56362-02	47306			
56375-96	47264		47830	47831
56401-96	47260			

THROTTLE CABLES

	Black Vinyl		Stainless Steel	
	STD	+6"	STD	+8"
Sportster Models				
XLH 883 1986-87	47208	47209		
XLH 883 1988-95	47212	47213	47800	47801
XLH 883 1996-99	47240	47241	47804	47805
XLH 883 Deluxe 1987	47208	47209		
XLH 883 Deluxe 1988-95	47212	47213	47800	47801
XLH 883 Hugger L1987	47208	47209		
XLH 883 Hugger 1988-95	47212	47213	47800	47801
XLH 883 Hugger 1996-99	47240	47241	47804	47805
XLH 883C Hugger 2000-01	47270			
XLH 883R 2002-03	47240		47804	47805
XLH 1100 1986-87	47208	47209		
XLH 1200 1988-95	47212	47213	47800	47801
XLH 1200 1996-99	47240	47241	47804	47805
XLH 1200 C 1996-99	47240	47241	47804	47805
XLH 1200 S 1996-03	47258			
XLH 1200C 2000-01	47270			
XLH 1200C 2002-06	47258			

IDLE CABLES

	Black Vinyl		Stainless Steel	
	STD	+6	STD	+8"
	47210	47211		
	47214	47215	47802	47803
	47242	47243	47806	47807
	47210	47211		
	47214	47215	47802	47803
	47210	47211		
	47214	47215	47802	47803
	47242	47243	47806	47807
	47272			
	47242	47243	47806	47807
	47210	47211		
	47214	47215	47802	47803
	47242	47243	47806	47807
	47242	47243	47806	47807
	47260			
	47272			
	47260			

For Big Twin Models

FLHR 1994-95	47220			47222			
FLHR 1996-01	47262		47828	47829	47264		47830 47831
FLHR 2002-04	47304				47306	47321*	
FLHR-I 1996-01	47246				47247	47323*	
FLHR-I 2002-04	47304				47306	47324*	
FLHRC-1 1998-99	47248				47247	47323*	
FLHRC-1 2000-01	47246				47247	47323*	
FLHRC-1 2002-04	47304				47306	47324*	
FLHS L1987-89	47216		47812	47813	47218		47814 47815
FLHS 1990-95	47220		47824	47825	47222		47826 47827

*Cruise cable (extra length)

Barnett Cables

	THROTTLE CABLES				IDLE CABLES			
	Black Vinyl		Stainless Steel		Black Vinyl		Stainless Steel	
	STD	+8"	STD	+8"	STD	+8	STD	+8"
FLHT 1984-89	47216		47812	47813	47218		47814	47815
FLHT 1990-95	47220				47222			
FLHT 1996-01	47262	47263	47828	47829	47264	47265	47830	47831
FLHT 2002	47304				47306			
FLHT 2003	47314							
FLHTC 1983	47204	47205	47808	47809	47206	47207	47810	47811
FLHTC 1984-89	47216		47812	47813	47218		47814	47815
FLHTC/U 1990-95	47220		47824	47825	47222		47826	47827
FLHTC 1996-01	47262	47263	47828	47829	47264	47265	47830	47831
FLHTC 2002	47304				47306			
FLHTC 2003	47314							
FLHTC-1 1996-01	47248		N/A					
FLHTC-1 2002-06	47304				47306			
FLST 1986-89	47204	47205	47808	47809	47206	47207	47810	47811
FLST 1990	47234	47235	47816	47817	47236	47237	47818	47819
FLSTC L1987-89	47204	47205	47808	47809	47206	47207	47810	47811
FLSTC 1990-95	47234	47235	47816	47817	47236	47237	47818	47819
FLSTC Heritage, FLSTC-I								
Heritage F/I 2001-03	47310				47312			
FLSTF 1990-95	47234	47235	47816	47817	47236	47237	47818	47819
FLSTF 1996-99	47249	47250	47820	47821	47251	47252	47822	47823
FLSTN 1993-95	47234	47235	47816	47817	47236	47237	47818	47819
FLSTN,C,F 1996-99	47249	47250	47820	47821	47251	47252	47822	47823
FLSTS 1998-99	47254				47256			
FLSTS 2000	47249				47251			
FLSTS, FLSTS-I 2001-03	47310				47312			
FLT 1984-86	47216		47812	47813	47218		47814	47815
FLTC 1984-89,Ultra 1989	47216		47812	47813	47218		47814	47815
FLTC 1990-95, Ultra	47220		47824	47825	47222	47322*	47826	47827
FLTCU-I 1996-2000	47248				47247			
FLTR 1998-2001	47262				47264			
FLTR 2002	47314				47316	47325*		
FLTR-I 1998-99	47246				47247			
FLTR-I 2000-01	47248				47247			
FLTR-I 2002-03	47304				47306			

*Cruise cable (extra length)



Throttle Clamp Sets

Chrome die-cast clamp sets include the upper and lower clamp with screws.

PCP Type
4785 Dual cable clamp set



Radii Billet Throttle

Accepts single 1982-95 throttle cable.
73662

Chrome Dual Billet Throttle Housing

For use with idle and throttle cable.
73713



Barnett Cables

	THROTTLE CABLES				IDLE CABLES			
	Black Vinyl STD	+8"	Stainless Steel STD	+8"	Black Vinyl STD	+8	Stainless Steel STD	+8"
FXD 1996-03	47249				47251			
FXDB, FXD, D/Glide 1991-95	47234	47235	47816	47817	47236	47237	47818	47819
FXDL, FXDWG 1993-95	47234	47235	47816	47817	47236	47237	47818	47819
FXDL 1996-03	47249				47251			
FXDS-CONV, FXDWG 1996-03	47249				47251			
FXDWG w/OEM stainless			47820				47822	
FXDX 2000-03	47249				47251			
FXDXT 2002-03	47249				47251			
FXEF 1981-85	47204	47205	47808	47809	47206	47207	47810	47811
FXLR 1987	47224				47225			
FXLR L/Rider Custom 1988-89	47238				47239			
FXLR L/Rider Custom 1990-95	47234	47235	47816	47817	47236	47237	47818	47819
FXR 1982-89	47204	47205	47808	47809	47206	47207	47810	47811
FXR Superglide 1990-94	47234	47235	47816	47817	47236	47237	47818	47819
FXRC L1985-L87	47204	47205	47808	47809	47206	47207	47810	47811
FXRD 1986	47224				47225			
FXRDG L1984, FXRS 1982-89	47204	47205	47808	47809	47206	47207	47810	47811
FXRS 1990-95	47234	47235	47816	47817	47236	47237	47818	47819
FXRS Convertible L1989	47204	47205	47808	47809	47206	47207	47810	47811
FXRS Convertible 1990-95	47234	47235	47816	47817	47236	47237	47818	47819
FXRS Sport Edition L1985-86	47204	47205	47808	47809	47206	47207	47810	47811
FXRS Sport Edition 1987-89	47224				47225			
FXRS Sport Edition 1990-93	47234	47235	47816	47817	47236	47237	47818	47819
FXRT 1983-89	47224				47225			
FXRT 1990-92	47234	47235	47816	47817	47236	47237	47818	47819
FXSB 1983-85	47204	47205	47808	47809	47206	47207	47810	47811
FXST 1984-89	47204	47205	47808	47809	47206	47207	47810	47811
FXST 1990	47234	47235	47816	47817	47236	47237	47818	47819
FXST 1996-2000	47249				47251			
FXST std, FXST-I std F/I 2001-03	47310				47312			
FXSTB 1999	47326				47328			
FXSTB, FXSTB-I Nite Train 00-03	47326				47328			
FXSTC 1986-89	47204	47205	47808	47809	47206	47207	47810	47811
FXSTC 1990-95	47234	47235	47816	47817	47236	47237	47818	47819
FXSTC 1996-99	47249	47250	47820	47821	47251	47252	47822	47823
FXSTD 2000	47249				47251			
FXSTD, FXSTD-I Duece 2001	47310				47312			
FXSTD Duece 2002-03	47310				47312			
FXSTD-I Duece F/I 2002-03	47310				47312			
FXSTS L1988-89	47226	47227 +6"			47228	47229 +6"		
FXSTS 1990-95	47230	47231 +6"			47232	47233 +6"		
FXSTS 1996-99	47254				47256			
FXSTS 2000-03	47254				47256			
FXSTS-I, Springer F/I	47254				47256			
FXSTSB 1995	47234	47235	47816	47817	47236	47237	47818	47819
FXSTSB 1996-97	47249	47250	47820	47820	47251	47252	47822	47823
FXWG 1981-86	47204	47205	47808	47809	47206	47207	47810	47811
VRSCA, V-Rod 2002-07	47318				47320			



Dual 1981-95 Push-Pull Kit

PCP Application
59740 1981-90 Kit w/Barnett cables
59741 1991-95 Kit w/Barnett cables

38" Throttle and Cable Kit

Kit includes grips, throttle idle and Barnett throttle cable with ends attached for S&S Super E and G carbs.
59739