

Section 10A

Dash

Cables 17-18

Dash 2-8

Gauge Mount 9, 16

Lamps..... 8, 9

Speedo 10-15

Speedo Drive17

Tank Dividers 6



Black Replica Cateye Dash Kit 1939-41
Replica 1939-41 style dash panel profile to fit BT1939-46.
Includes dash trim, red and green cateye lenses.
19881



Black Replica Cateye Dash Kit 1942-46
Replica 1942-46 style dash panel profile to fit BT1939-46.
Includes dash trim.
19882

Big Twin Dash



2 Light Fat Bob Speedo Kits

Complete kit allows for a trouble-free installation when converting to Fat Bob tanks. Kit includes 2-light dash cover, 120 mph speedometer, dash base plate (with wiring, sockets and hardware) and ignition switch.

2:1 Ratio

6305 52-83 XL; 36-67 FL; 73-90 FX, FXR with front Speedo

1:1 Ratio

6304 68-83 FL, FX with trans drive speedometer cable



Late FLH Diecast Dash Kit 1968-84

Includes cast type dash, speedo, switch, choke mount and knob, hardware and rubber strips. Stock on 1968-84 FL-FLH. Can be adapted to all 3-1/2 & 5 gal. tanks 1948-84 features dash base with wirings and sockets. Complete dash kit available as:

6300 1:1 Ratio

6301 2:1 Ratio

90151 2240:60 Ratio



3 Light Dash and Speedometer Kits

Complete kits with a speedometer, dash, trim, dashplate with light socket, ignition switch, and available with either 1:1 or 2:1 ratio speedometers.

6302 3 Lite 1:1 FL-FX 1963-83 trans drive only

6303 3 Lite 2:1 1936-61 trans drive, all FWD 1973-81

17203 Lense kit w/2-red and 1-blue (71091-59, 71351-59)



1977-84 FXS Complete Dash Assembly

Includes chrome cover, electric tach, speedometer drive, trip cable, indicator lamps, mount hardware and cable.

59445



Cateye Dash Kits

Can be mounted on all 74"-80" Big Twins 1936-1983, and 45 models 1936-1953, 1936-73 Servi-Car models.

6306 1:1

6307 2:1

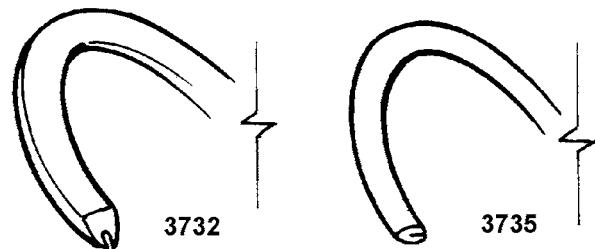

Dash Board Rubber Strip

Protect tank paint off tank & reduce vibration.

Black except where noted.

PCP Fits

3729 Cateye dash 1936-46

3735 Fits 2 & 3 light dashes 1947-67 (71294-47)

3739 (White) Fits 2 & 3 light dashes 1947-67 (71294-47)

23100 27" Chrome edge trim

3732 Fits FL dash 1968-on (71295-68)

651 Fits FXS dash 1977-84

Big Twin Dash



2 Light Dash Cover for Fat Bobs

Show chrome 2-light style dash complete with lenses; (generator & oil). Replaces 71274-61T.

1283 1947-61 FL

3735 Dash rubber 1947-67



3 Light Dash Cover for Fat Bobs

Show chrome 3-light style dash complete with lenses; (generator, oil & neutral). Replaces 71272-62T.

1282 1962-67 FL

1350 3-light dash red lens (2 used) plastic

1349 3-light dash blue lens (1 used) plastic



Plain Chrome Dash

Chrome steel dash can be used on 2 or 3 light bases, when switch and indicator lights are not desired. Mount hole must be drilled. Great on the FXS conversion when switch is left in stock position.

5796



Chrome Dash Kit for Fat Bobs (less Speedo's)

Complete kits feature: chrome dash cover, base plate assembly, ignition switch and mounting hardware.

91200 Cateye

91201 2-Light

91202 3-Light



Cateye Dash Cover for Fat Bobs

Show-chrome cateye-style dash complete with lenses. Replacement lenses sold individually.

1284 Chrome

3729 Dash rubber 1936-47

1352 Cateye red lens plastic (each)

1351 Cateye green lens plastic (each)

1890 Dimmer switch (71600-39)

1798 Dash plate mounting kit 1936-46



Cateye Skull Speedo Cover

45168

Dash



2925



Late Style Cast Dash

Die cast chromed dash is a replica of the OEM part. Dash includes lenses, light divider and trim rubbers. Can be used on most 4-speed frames and Softails when the correct dash base is used.

PCP Description

2925 Dash FL 1968-84, FXWG 1980-86 and FX 1971-72 (71241-68B)

3732 Trim rubbers (71295-68) (pair)

Chrome Dash for FXR

Chrome replacement dash fits all 1982-84 FXR models.

2906 Replaces 61411-82, 61412-82 & 61414-82

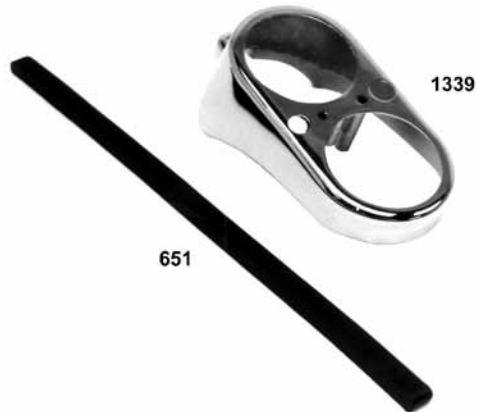

1339

651



Chrome Long Rider Dash Panel

This panel is designed for "Bob" tanks on FLH and FXWG models, 1968-84. Rubber strip included.

45430

Die Cast Chrome Dash for FX 1977-84

Heavy, die-cast instrument housing for tank mounted gauges on FX models 1977-1984. Same thickness and construction as the original equipment part, PCP trim rubber (#651) and chrome mounting hardware (#5366), will fit perfectly.

1339 Dash cover only.

651 Trim rubber

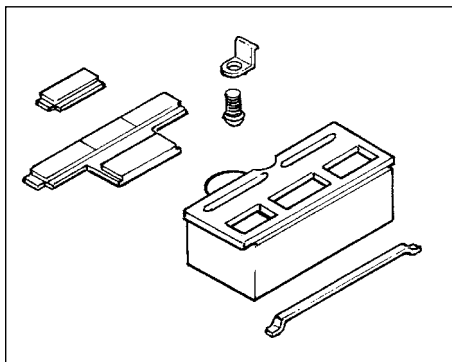

Diecast FL Dash Hardware Kit
Includes all parts pictured to fit the FLH-FXWG 1975-95 cast type dash.

786 Hardware kit

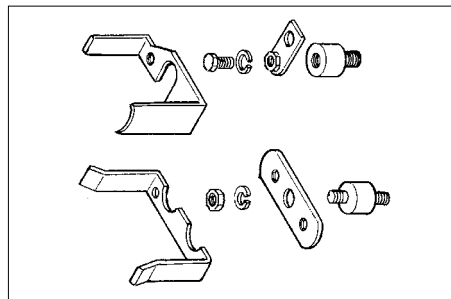

Low Rider Dash Mounting Kit

Used for installing FX tank mounted twin pod gauges on pre-1985 3.5 or 5.0 gallon Fat Bob tanks. Reproduction kit includes speedo and tach cup brackets, hardware and the correct rubber mounts.

1340 Contains all parts pictured



Dash Mounting Kit

4-Piece set of chrome plated (button head, socket style) dash panel screws for all Low Rider and FX tank mounted gauge covers.

5366 Buttonhead 1977-85 FX

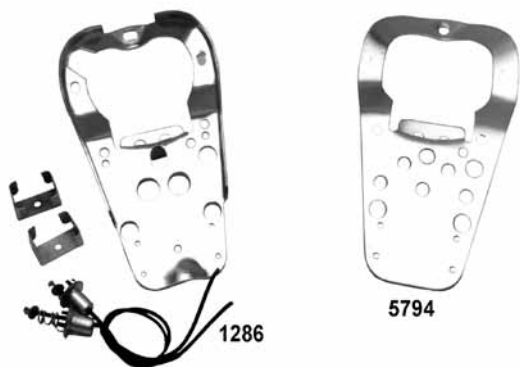

Dash Mounting Plates

2 Light dash mounting plate includes wiring and sockets. Basic mounting plate # 5794 is for use with Fat Bob dash covers 1283 and 1282 when dash lighting is not desired.

1286 2-light dash mounting plate with circuit breaker clips: fits PCP dash 1283

5794 Base only (without dash lights)



3 Light Dash Mounting Plate

Includes wiring and sockets.

1285 Fits PCP dash #1282 and #2925

5249 Centre screw for tin dash

1799 Dash cover bolt kit BT 1947-67



Late-Style Cast Dash Mounting Plate

Complete mounting kit for BT 1968-84 with cast-style dash. Includes necessary hardware to fit standard early-style Fat Bob tanks and later-style flatside Fat Bob tanks.

48600 Fits PCP# 2925 dash kit for 1968-on

4397 Replacement dash light socket (each)



Replica Wiring Harness/Dash Base Assemblies

Includes harness pre-wired to dash base, five or six post key switch, terminal box, horn button, dimmer switch, headlamp connection, speedometer lamp socket and front terminal board when required

Generator Models			
PCP	Type	Application	Generator
28718	2-Light	1947 BT	
28662	2-Light	1948 BT	3 Brush
28663	2-Light	1949-57 BT	3 Brush
28664	2- Light	1958 BT Neutral	2 Brush
59148	2-Light	1959-61 BT Neutral	2 Brush
28665	3-Light	1962-64 BT	2 Brush
28717	2-Light	1939-46 BT	3 Brush
BT Electric Start Models			
PCP	Type	Application	Generator
28724	3-Light	1965-67	2 Brush
28725	5 Light	1968-69	2 Brush
28666	5-Light	1970-71	
28671	5 Light	1972	
28726	5 Light	1973-77	
28675	5 Light	1978-79	
28676	5 Light	1980-84	

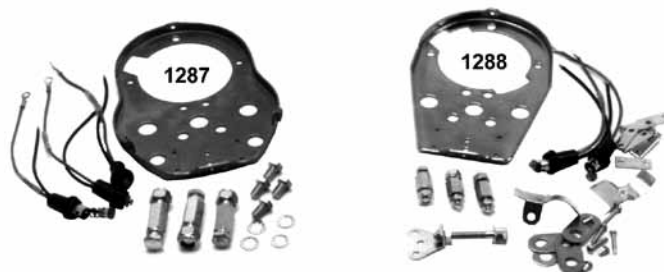

Cateye Dash Mounting Plate

Includes wiring and sockets.

1287 Cateye dash mounting plate: fits PCP dash #1284 when mounting on 1936-46 H-D Fat Bob tanks only.

1288 Cateye dash mounting plate for 1947-83 tanks: fits PCP dash #1284.

Tank Dividers

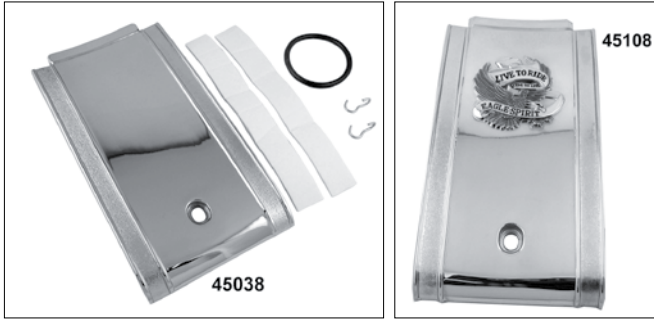

Chrome Diecast Dash Panel

Chrome diecast dash panels replace the rubber unit found on FXWG models 1980-1986. Easily installed with stock hardware. Available in smooth or with a "Live to Ride" emblem. Dashes also work on earlier Big Twin custom applications with Fat Bob® tanks and single instrument diecast dash.

- 45038** Plain chrome trim panel
- 45108** Chrome "Live to Ride" trim panel

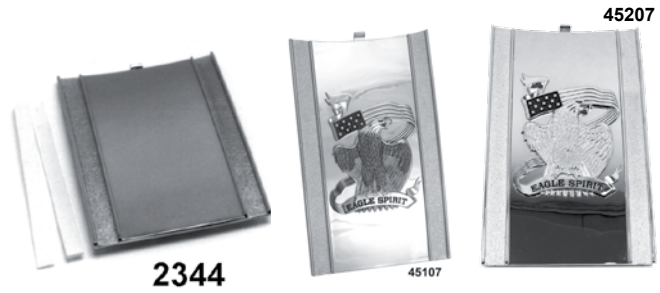

Die Cast Tank Trim Panel

These diecast chrome dash panels fit FL, FXWG models 1968-on with frame mounted seats. Available plain or with our new embossed "Eagle Spirit" emblem in chrome or gold over chrome versions. Replaces OEM 61118-81.

- 2344** Plain chrome trim panel 1968-99
- 45107** Chrome "Eagle Spirit" trim panel
- 45207** Gold over chrome "Eagle Spirit" trim panel

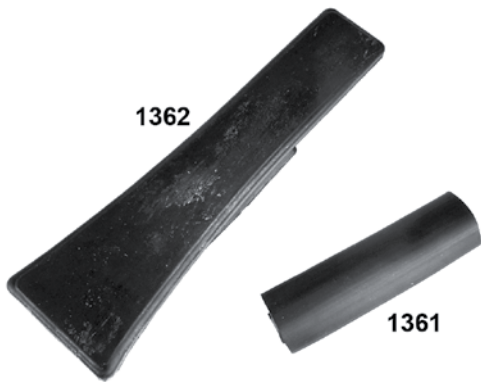

Stock Tank Divider

Fits all Fat Bob tanks.

- 1361** Black, for use with seat "T" bar(61122-39)
- 1362** Black, use to fill in "T" bar area



Chrome Louvered Dash Plates

Chromed steel dash plates with louvers are available to fit in the recessed area of all FXR dashes or 68-92 Fat Bob gas tanks. To mount the FXR version, the stock dash must be drilled to mount the dash plate (hardware not included). The Fat Bob version has protective foam backing to protect the paint.

- 45028** Chrome louvered dash plate for 68-92 Fat Bob
- 45029** Chrome louvered dash plate for 82-92 FXR



Dash Panel for Fat Bobs

Perfectly chromed and formed dash panel covers the gap between Fat Bob gas tanks.

- 405** Plain



Tank Trim for FXS, FXEF

Chrome centre panel for the split tanks of 77-84 FXS, FXSB, FXEF and FXB.

- 647** Plain
- 3286** Bracket Set for above



Dash Panel for Fat Bobs

Used on Fat Bob tank applications when dash or instruments are not mounted on tanks.

- 3138** Plain



Early Style Dash Light Divider

Divider fits all early style steel, 3 light dashes.

17101 71292-62



Late Dash Plate Spacers

Used to space dash base to frame when lining up tanks.

11707 .030 (71027-68) (10 pack)

11708 .060 (71028-68) (10 pack)

11709 .120 (71029-68) (10 pack)



Speedo Block-Out Kit

Chrome block-out plate for BT speedo.

1422



Small Dash Plug

1887 10 pack

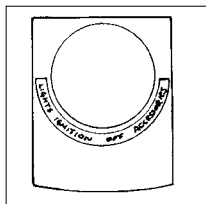

Dash Panel Decal

Replaces OEM 71300-79 on all FL, FLH, FXWG models 1979-93. Black matt finish with adhesive backing.

5193 Each



Indicator Decal

22160 2 Hole, neutral-oil pressure XL-FX 1973-on (67832-73)



Replacement Lenses for Fat Bob Dash Cover

Can be used to restore original equipment or as replacement parts for PCP dash plates.

Note: Below sold each.

1353 2-light dash red plastic lense



FL Dash Lense Support 68-95

48012 71134-68



Dash Mount Stud Kits

This little kit includes a stud, nuts, nylon washer and either a Skull or Acorn nut. It will fit 1968-on cast dash panel on FL-FXWG when choke cable is not used.

44013 Acorn style kit



Fat Bob Dash Stud & Screw

Kit includes chrome centre screw and stud without choke cable hole.

PCP Fits

1799 1947-67 FL H-D (71075-47)

5249 Centre screw only



Allen Bolt Custom Cap Covers

These cap covers are sized by bolt thread diameter. Chrome plated and machined from aluminum, these caps come with set screws and an allen wrench. **Sold in pairs.**

45310 1/4"

45311 5/16"

45312 3/8"



Dash Panel Bracket Set

A custom bracket mounts a dash panel directly to the frame, eliminating panel movement and vibration.

3286 Bracket set only

Dash Lights

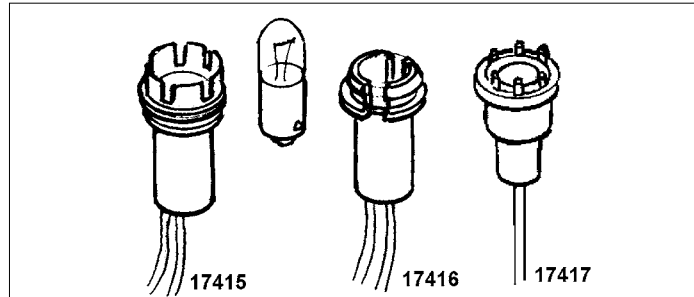

Dash Indicator Lamp Sockets-3 PK

PCP	Fitment	Type	Wires
17415	FL 41-84	Metal	2
17416	FL 41-84	Plastic	2
17417	FL 41-46	Metal	1

Speedo Or Tach Indicator Lamp Sockets-Each

PCP	Fitment	Wires	OEM
1511	FL 48-85	1	71151-48
3721	BT 48-on	1	71151-70
19658	FL 48-84	1- Cloth	
4397	BT 68-99	2	
1504	FX, XL 67-73	1	71151-67B
17405	FX, XL 76-77	1	92045-76
1421	FX 78-84, XL 78-85	1	67327-78
17414	FXR, XL 83-86	2	67034-83
17412	FX, XL 83-90		67107-83

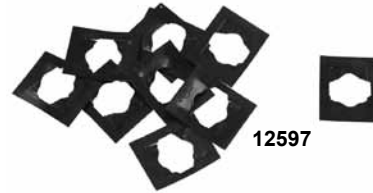

Dash Indicator Lamp Hardware

PCP	Item	Fitment	OEM	U/M
12502	Nut- 1/2" Diameter	FX, XL 75-82	7614	5 Pk
12597	Nut	FX, XL 83-on	68608-83	10 Pk



Dash Indicator Lamps-Each

PCP	Fitment	Colour	Type	Wires	OEM
62002	FX, XL 75-85	Green	Hi-Beam, Neutral, Generator	2	67851-75
62003	FX, XL 75-85	Red	Oil Pressure	2	68536-75
1342	FX, XL 75-85	Red	Hi-Beam	1	67891-75B
17410	FX 73-82	Red	Hi Beam	1	67891-68
17419	FX 73-82	Red	Hi-Beam lens only for #17410		67899-68A
17420	FX 72-74	Red	Generator	2	68536-72



Speedo Cable Clamps

Exact duplicate of original Harley clamps.

Item	PCP	Application	Finish	OEM
A	9646	74 OHV 36-51	Parkerized	67075-36
B	9650	OHV BT 52-56	Parkerized	67075-52
C	9651	OHV BT 57-61	Parkerized	67074-57
D	9652	OHV BT 61-80	Zinc	67074-57A

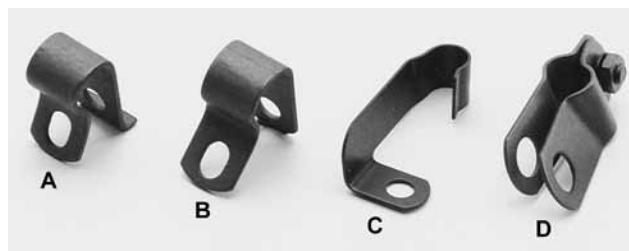

Accessories

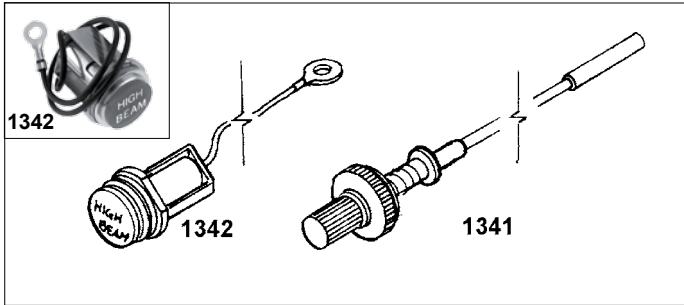

Odometer Reset Cable for FX

The complete odometer reset cable assembly for all four-speed FX models 1973-84 (except FXWG). Includes chrome knurled knob, rubber grommet, washer, spring and flexible cable—fully assembled, ready to install.

1341 67210-73

Hi-Beam Indicator Lamp

Original style, high beam indicator lamp assembly. Fits as original equipment on FX 1973-74, as well as XL models 1968-1973. Can also be used to replace the later one-piece indicator lamp used on FX models 1975-on.

1342 67891-75B

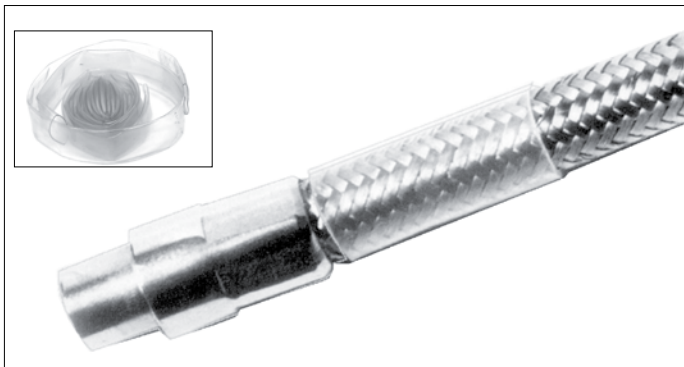

Heat Shrink Tubing

Use clear heat shrink tubing on all braided stainless steel cables to help prevent scratching of chromed or painted surfaces. Kit contains 4-16" long heat shrink tubes to cover 2 throttle cables, 1 clutch and 1 speedo cable.

PCP Application

28713 Cable sleeve kit
28714 3/8" x 10' roll
28715 1/2" x 10' roll
28716 3/4" x 10' roll

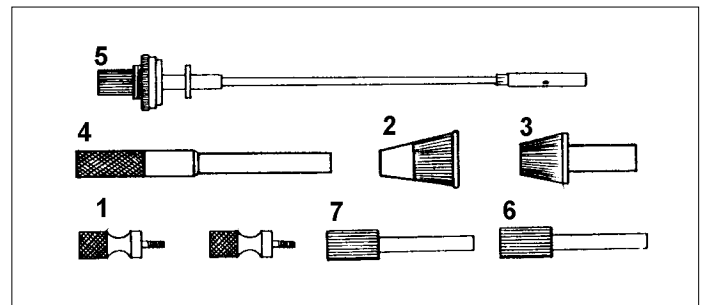

Odometer Reset Knobs

#	PCP	Description
1	48000*	Knurled 1968-84 (5 pack)
1	48003*	FL 1981-95 (each)
2	48001	FLH 1968-84 (67215-68) (5 pack)
	24553	Screw for above (67217-68) (10 pack)
3	48002	FXWG 1981-95 (67215-89) (5 pack)
	24540	Screw for above (67117-85) (10 pack)
4	48004	All female (each)
5	1341	Chrome FXE 1973-84 (67210-73)
7	48006	Chrome XL 1985-94 (67108-83) (ea)

*Note: Knurled type fits most aftermarket FL gauges

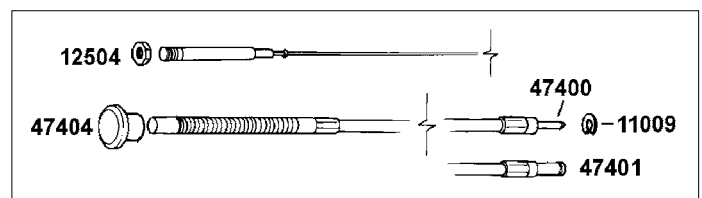

FLH Choke Cable

Complete assemblies include chrome knob casing and inner wire, for dash mounting.

PCP Application

PCP	Application
47400	1971-78 FLH Complete assembly (29212-71)
47401	1979-84 FLH Complete assembly (29213-79)
47403	1971-78 Inner wire, 19"
47404	Chrome knob (29214-71)
47405	1982-85 FLT choke cable (29225-79) (no knob)
12504	1966-78 Nut (7608) (10 pk)
11009	1979-on Retaining ring (11013) (10 pk)

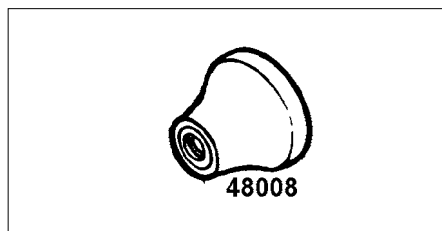

Black Choke Knobs

For use when choke is located on top motor mount, as well as, on dash mounted models. FL 1967-70.

48008 (#8-32 thread) (29214-67A)



Chrome Rubber Mount Clamp

Clamp is used to attach gauges or mirror to frame or handlebar to reduce vibration. Fits 1" bar.

16501

Gauges



Custom Mini Speedo Gauges

Chrome speedometer gauges feature strong chromed steel mounts, rubber mount handlebar clamps, accurate non-fluctuating indicators, 12-volt dial light compact size (2 3/8x 2 1/16). Waterproof construction and vibration resistant.

Cable not included

Speedometers

737 (1:1 ratio) can be used on FL 1968-80, FX 1971-72, and 1980-83 FXWG's when connected to transmission speedometer drives.

47423 Black cable for transmission drive

738 (2:1 ratio) can be used on XL 1954-on, FX 1973-78, BT 1936-80 when connected to transmission speedometer drives; XL 1973-90, FX 1973-90, and FXR 1982-90 when connected to front wheel speedometer drives. MPH Face.

530 Standard cable 39"

528 + 4" cable

Mini-Speedo and Tach Kits-MPH

Custom Speedometer and Tachometer Kits

Complete kits include custom instruments with a resilient rubber mount handlebar clamp and custom cable. Gauges measure 2-5/8" wide x 2-1/16" deep. Permits easy installation on models with stock length forks without any need for additional adapters or modifications.

PCP	Type	Years/Model
6628	2:1 Speedo	1954-72 XL, 1936-67 FL
48463		As above, white 1.900" O.D.
6629	2:1 Speedo	1973-90 XL, 1973-86 FX, 73-on FXR 1981-84 FL 0-140 MPH
48464		As above, white 1.900" O.D.
6630	1:1 Speedo	1966-80 FL, 1971-72 FX, 80-83 FXWG
6627	Tach	1971-80 Sportster
48465		As above, white 1.900" O.D.
739	Tach only	Electric 3-wire type (8000RPM)
48466		As above, black 1.900" O.D.
48508		As above, white 2.400" O.D.

Note: To use **739** on 1978-on models with coil triggered tach, the Green Negative wire goes to ignition side of coil. Red wire goes to breaker side. Tach head must be grounded by black wire.

Cable **47423** fits kits **6628** and **6630**.

Cable **530** fits kit **6629**.



60mm Mini Speedo with LED Indicators to 1995

Speedos feature a white face, 4 indicator lights and a reset knob. Blue indicator light for high beam, green light for neutral, red light for oil, and yellow light for turn signals.

PCP Application

48467 2:1 Speedo MPH

48468 2:1 Speedo KPH



48559

48558



48460

48461

48462

2.850" O.D. Mini Gauge Kit

Kits include gauge, chrome mounting bracket (no visor), chrome gauge cup, rubber grommet and hardware. Fits most BT and XL 1973-on.

PCP	Description
48459	2:1 MPH Speedo
48460	2240:60 MPH Speedo
48461	2:1 KPH Speedo
48462	Tachometer, coil driven

Tech Tip

Black = ground
Red = (+) coil
Green = (-) coil
Blue = light

Mini-Speedos XL 1954-72, FL 1936-67

48558 2:1 Speedo MPH with trip knob

48559 2:1 Speedo KPH with trip knob

Speedometers

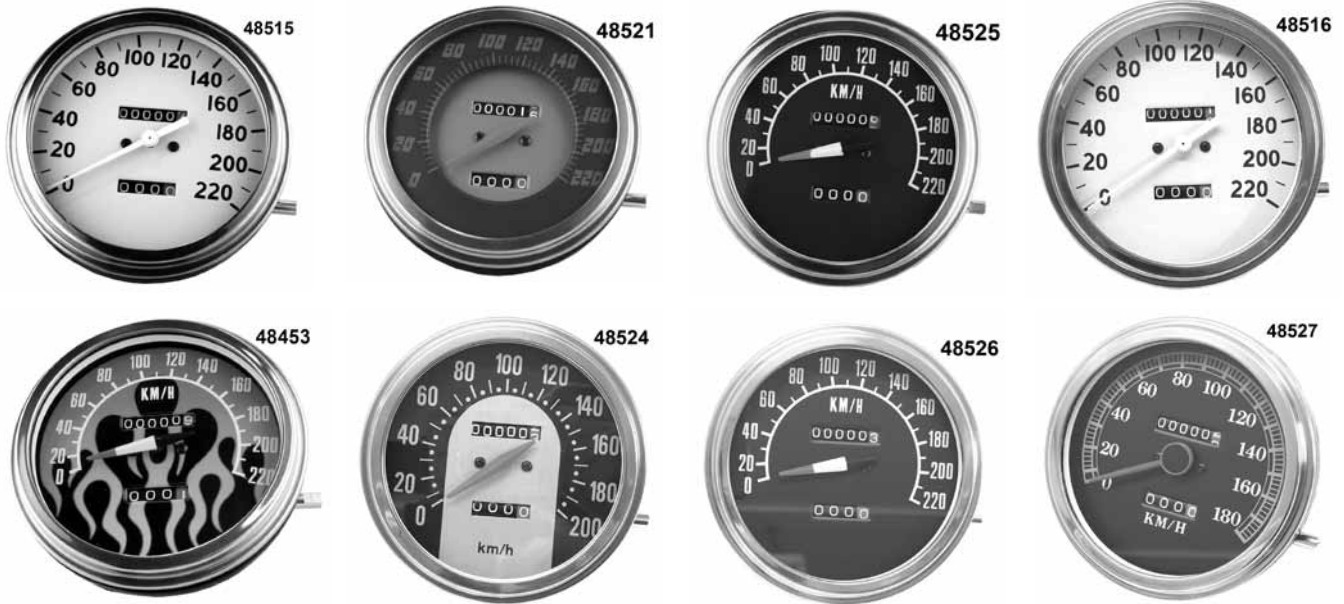

KPH Speedometers

They are offered in a variety of face styles and feature trip meters. All speedometers accept 5/8-18 threaded cables, (late model front wheel drive cables will not fit, #2538 custom cable will adapt these gauges to those models). When used with early tin dashes our #48000 antique reset knob must be used. For diecast dashes use our #3720 (1968-84 style),

1:1 Ratio Speedometers (700RPM=60KPH)

Fits FL 1962-80, FX 1971-72, & FXWG 1980-83 with transmission drive unit.

- 48515** 1936-40 white face with black numbers
- 48521** 1948-61 tan & black face with green numbers
- 48525** 1968-84 black face with white numbers
- 48453** 1947-90 flame design face with 5/8-16" fitting

2:1 Ratio Speedometers (1400RPM=60KPH)

Fits FL 1947-61 & 1981-84 with transmission drive unit, FX 1973-84 with front wheel drive units.

- 48516** 1936-40 white face with black numbers
- 48524** 1962-67 black face with 'zinc' coloured numbers
- 48526** 1968-84 black face with white numbers
- 48527** 1985-on new style, black face with white numbers



48mm Mini Speedo

- PCP Application**
- 48463** 2:1 Ratio, 48mm OD 1954-72 XL, FL 1936-67
 - 17039** Light socket with bulb all applications
 - 5779** 12V bulb (10 pk) all applications
- Note: Cable must be purchased separately**

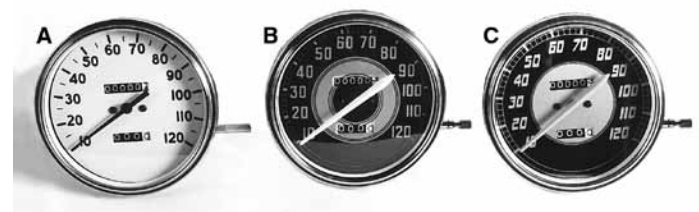

0-120 MPH Replica Domed Speedometers

Features domed glass lens with stainless narrow bezel in 2:1 ratio with a 5/8" male cable fitting. Includes reset knob.

- PCP Application**
- 48444** (A) 1936-39
 - 48445** (B) 1940-45
 - 48446** (C) 1946-47

Chrome Trans Drive Speedometer

- 0-120 MPH, 1:1 speedo.
Bullseye 1941-45 style with black face and silver design.
59738



Speedometers



48400



48412



48416



48420



48432



48428



48401



48413



48414



48417



48418



48419

MPH Speedometers, Big Twin Dash 1968-on

Offered in 1:1 and 2:1 ratios with the newer style re-set knob (for cast dashes). Available with a 5/8-18 thread for transmission drive unit, or for front wheel drive. Rubber isolation ring and mount kit included.

1:1 Ratio Speedometers (1000RPM=60MPH)

Fits FL 1962-80, FX 1971-72, and FXWG 1980-83 with transmission drive unit.

- 48400 1936-40, off white face with black numbers
- 48412 1948-61, tan & black face with green numbers
- 48416 1962-67, black with 'zinc color' numbers & center
- 48420 1968-84, black face with white numbers
- 48432 1989-on, black face with numbers
- 48428 'Police' 120MPH, black face with white numbers



48421



48423

2:1 Ratio Speedometers (2000RPM=60MPH)

Fits FL 1947-61 with transmission drive unit, FL 1981-84, FX 1973-84 with front wheel drive units. (12mm speedometers use stock front cable)

- 48401 1936-40, off white face with black numbers
- 48413 1948-61, green & black face with silver numbers
- 48414 1948-61, as above but with 12mm threads for FWD
- 48417 1962-67, black with 'zinc color' numbers & center
- 48418 1962-67, as above but with 12mm threads for FWD
- 48419 1962-67, as above but 2240rpm=60mph
- 48421 1968-84, black face with numbers
- 48423 1968-84, as above FWD with 2240RPM speedo for FXST=60MPH
- 48429 'Police' 120MPH, black face with white numbers
- 48431 'Police' as above, 12mm / FWD & 2240rpm=60mph



48429



48431

SPEEDOMETER RATIO GUIDE			
TRANSMISSION DRIVE		FRONT WHEEL	
FL 1941-E61	11 Tooth 2-1 Ratio	FX 1973-79 & 81 On	2-1 Ratio
FL L1961	13 Tooth 2-1 Ratio	FX 1980	1:1 Ratio
FL 1962-68	13 Tooth 2-1 Ratio	FL 1981-84	2240:60 Ratio
FL 1969-80	23 Tooth 1-1 Ratio	FXST & FXWG	2240:60 Ratio
FX 1971-79	23 Tooth 1-1 Ratio		
	& 1981		
ALL 45's with rear wheel drive are 2:1 Ratio			

Speedometers



3731



2298



3745



3738



3748



3728



2309



3734



3752



48511



48512

MPH Speedometers for BT Tin Dash Pre-1968

These top quality units are offered in 1:1 and 2:1 ratios with the old style solid reset knob (not for cast dashes). A full selection of replica faces are available and **all have a 5/8-18 thread** for transmission drive unit, or for front wheel drive use cable #2538 (38.5"). Rubber isolation ring included.

1:1 Ratio Speedometers (1000RPM=60MPH)

Fits FL 1962-80, FX 1971-72, and FXWG 1980-83 with transmission drive unit.

- 3731 1936-40, off white face with black numbers
- 2298 1941-45, Bullseye, black face with silver numbers
- 3745 1946-47, black face with silver numbers
- 3738 1948-61, tan & black face with green numbers
- 3748 1962-67, black with 'zinc color' numbers & center

2:1 Ratio Speedometers (2000RPM=60MPH)

Fits FL 1947-61 with transmission drive unit, FL 1981-84, FX 1973-84 with front wheel drive units.

- 3728 1936-40, off white face with black numbers
- 2309 1941-45, Bullseye, black face with silver numbers
- 3734 1956-61, tan & black face with green numbers
- 3752 1962-67, black with 'zinc color' numbers & center
- 48511 'Police' 120MPH, black face with white numbers
- 48512 'Police' as above with 12mm threads for FWD cable

Connect: Red to ignition switch side, Green to breaker side of coil. Speedo-tach head must be grounded



2:1 FL Speedo with Tach

The 2:1 ratio unit is designed to work with OEM transmission speedometer drive units on 1947-67 FL's, as well as late model front wheel speedometer drive applications (OEM drive 67127-73, #2533 OEM 67073-81, #2547. Built-in electric tach operates from coil impulse. When used in front wheel drive applications, use our custom speedo cable #2538.

1315 1981-84 FL front wheel drive uses custom cable



Speedo Drive Adapter Kit 1973-84

Kit includes 2:1 ratio right side speedo drive, chrome hub cover and chrome axle with nuts. Fits single disc FL spoke hubs and cast wheels 1981-85 style. FXWG kit includes adapter flange, 2:1 ratio speedo drive and axle to fit 1980-83 FXWG dual disc spoke hubs.

- | PCP | Application |
|-------|-----------------|
| 43300 | FLH single disc |
| 43301 | FXWG dual disc |

Gauges



2410



3537



1:1 MPH Speedometer and Tachometer

Speedometer has a ratio of 1:1 and features a built-in electric tachometer to operate from coil impulse. Fits FL 1962-80, FXWG 1980-1983.

48501



3284



48556

Speedometers

PCP	Face/Type	Models
2410	0-140 Mph	1973-82 FX, XL (67074-84T)
3537	0-120 Mph	As above (67020-73B)
3284	0-150 Mph	As above (67020-73B)
48556	0-120 Mph	1983-89 XL, 1983-84 FXRT, 1983-85 XLX (67037-85A)



48529



48530

MPH Speedo

PCP	Ratio	Application
48529	2:1	1981-90
48530	2240:60	1981-90



1:1 MPH Speedometer

Speedometer has a ratio of 1:1 and features a black background with white numbers reading 10-120 mph. Fits FL 1962-80, and FXWG 1980-83.

48528



48550



48557



27115

16502

27114

XLH-XLCH Tach & Speedo

Speedo and tach as shown are the plastic style used from 1974-83. Brackets are also sold separately.

PCP	Item
48550	Mechanical tach assembly 1974-83 (92051-74B)
2539	Standard cable 1974-80 (92065-74)
47297	33" Cable
48557	Speedo assembly (92020-74B) (also 82-83 FXR)
27114	Chrome speedo bracket (67316-74)
27115	Chrome tach bracket (92116-74)
16502	Lens only (each)

FL Speedo Drive Unit

Exact replacement for the OEM part.

PCP	OEM	# Of Teeth	Years
4631	67130-36	11	1936-61
4632	67130-62	13	1962-68
4633*	67130-69T	23	1969-80

*(FL E69-80, FX 71-72, FXWG 80-83)

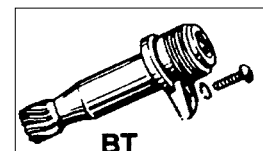

BT

Gauges



Replacement Tachometers

Original style tachometer with chrome rim features an 8000 RPM face. Available for FX, FXS, FXEF, FX-80, L1978-on. This tachometer will also replace the stock tach of FXs 1974-E78, by wiring the impulse lead to the points side of the coil. See late 78 wiring chart.

PCP Application

2479 1978-84 FX-FXS (92042-78A)

48553 1985-94 XL (67111-85)

2463



48560

Custom Mini Tachometer

Chrome tachometer gauges feature strong chrome steel mounts, rubber mount handlebar clamps, accurate non-fluctuating indicators, 12-volt dial light compact size (2 3/8 x 2 1/16). Waterproof construction and vibration resistant.

Cable not included

741 (2:1 ratio) fits all models with mechanical tach drives

47425 Tach cable XL 1962-70

2539 Tach cable XL 1974-80

739 Electric tachometer for 1978-on models w/coil triggered tach (8000RPM)

16501 Replacement handlebar gauge clamp

Mechanical Early Tach 1965-80

Use on 1965-80 XLH-XLCH 0-8000 RPM, mounts in 3-1/4" dia. hole. We have the cable which will connect this tach for use on all XL models 1971-on. Mount this in our single gauge housing.

PCP Application

2463 Tach 1965-73 (92051-65)

48560 Tach XL, FX cable driven 1970-73 (92051-70)

4870 Cable 1970-73 (92065-70)

47428 Cable 1965-69 magneto

47429 Cable 1965-69 distributor



1747 Tachometer drive block-off plug XL 57-84

Brackets & Covers



2222



2233



23009



23011



4249

Chrome Speedo & Tach Brackets

Fit FXR and all XL models. 23009 is the flexible black rubber visor. 1452 includes visor.

PCP	OEM	Lite	Years	Type
2233	67053-83T	3	1983-85	Single
2222	67110-83T	3	1984-91	Dual
23009	67039-83		1984-91	Rubber

Big Twin 'ISO-Support'

Is a molded rubber support to increase speedometer rigidity and reduce vibration for FL, FXST, & FLST models. Recommended used with our speedometer-iso mount pin kit 4249.

PCP Description

23011	Rubber support 1968-on (67115-91) (each) (shown mounted on speedo)
4249	Kit to mount speedo with 3/8" holes (67066-76)



3389

3393

3391



Chrome Dual Gauge Bracket

Speedo and tach mounting bracket for XL, XLCH 77-83, XLS 81-82, FXR 82-E83 and custom applications. Will work with plastic body instruments.

27093 92075-77



Chrome Speedo/Tach Trim

Attractive chrome trim installs over gauge bezel to fill the space between the gauge and mounting bracket or dash. Installs with silicone adhesive. Sold each.

55113 Fits speedo and tach on FX, FXR, FXD, XL 1983-95 (3-5/8" O.D.)

Speedometer-Tach Housing

Chrome single gauge holder houses Speedo or tach on FX or XL models 1973-on. Replaces 67181-73T. Good for holding tach on FX-FL Fat Bob conversions, when large FL type Speedo is used.

3391

Housing Speedometer and Tachometer

Replaces 90274-73T. Used on all 1974-82 FX, FXE, FXE-80 and 1973 XL's. Chrome plated.

3389

Gauge Mounting Cup

Replaces OEM 67180-73T. Used on both Speedo and Tach gauges on all 1973-82 FX, FXE, FXE-80, and 1973 XL. Chrome plated.

3393 Sold each



Chrome Speedo Adaptor Ring

Adapts late model FX speedo into any FLH style dash cover. (FLH Dash shown with adaptor ring installed. Ring must be affixed with industrial adhesive for a leak proof seal.)

5795



27192



27190



27193

FLH Speedo Tin Faces

Speedo must be disassembled to install.

PC #	OEM #	Application
27190	67004-62A	FL 1962-67
27192	67004-68C	FL 1968-80
27193	67004-68	FL Police 68-80



Speedo Drive Gear

Gear & shaft only for 1937-61 FL-FLH replaces 67135-36. II-Tooth type.

3888

Ignition Switch Covers

Custom ignition switches are designed to fit dash-mounted ignition switches on FL style 1936-86: with top hinged cover.

PCP Description

45124 Mirage

Speedo Drives



Front Wheel Speedometer Drive Units

PCP Fits

- 2533** 19" Wheel 1973-79. All FX's except FXWG 1981-83 All 1973-83 Sportster® (67127-73)
- 3306** 1980 only. All FX's except FXWG (67124-80)
- 3722** 19" wheel 1984-94. All FX's-FXR-1983-on, XL 1984-94 (67127-84A)
- 2547** 1981-84 FLH, 1982-87 FLT (67073-81)



Chrome Speed Drive Covers

These covers fit perfectly over the stock speed drive unit. Fits all Sportster® (not XR 1000), FX and FXR models with 35mm front forks 1973-83, FL 1981-84, FLT 1982-86 (right side).
45317

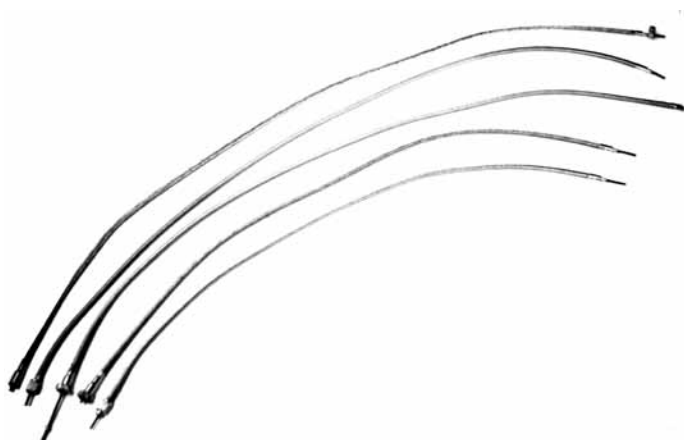

S.S. Braided Speedo Cables

47617 44" FWD speedo XL 1974-83



Speedometer Cable Rubber Boot

Fits all models with front wheel drive 1973-on. Replaces 94996-85.

5443 (5 pack)

Speedo/Tach Cables



Imported Cables

Black S.S. Description

FL Models

- 4201** FL's (Male end) 41-61 (67026-36A)
- 1356** FL, FLH 62-80 31" (67026-62)
- 2534** Same as Above +4"
- 2535** **47600** 81-85 FLH-80, Classic (FWD) (67026-81)
- 4391** Same as above +4"
- 2538** **47419** 40" Fat Bob Dash FWD, Custom
- 4391** 42.5" Fat Bob Dash FWD, Custom

FLT Models

- 3645** **47604** FLT 79-85 (67072-79)
- 3653** Same as above +4"

FXWG Models

- 1356** 1980-83 FXWG (67026-62)
- 2534** Same as above +4"

FX Models

- 1356** 1971-72 FX (67026-62)
- 527** **47602** 1973-78 FX (67051-73)
- 533** Same as above +4"
- 3629** 1978-86 FX's, 83-86 FXSB (67052-78B)
- 3663** FXE-80 1983-E84 Std. Length (67048-83)
- 3665** Same as above +4"

XL Models

- 47414** 1957-70 XL (67051-52A)
- 4862** 1970-72 XLH, XLCH (67051-70)
- 527** **47602** 1973 XLH, XLCH (67051-73)
- 533** Same as above +4"
- 530** **47603** 1974-83 All XL Models (67051-74)
- 528** Same as above +4"
- 4863** Same as above +6"
- 3637** 1979-82 XLS (67060-79A)
- 3629** 1983-86 XLX, 1984-up XL (67052-78B)
- 4864** 1984-86 XLS (67048-83A)
- 3661** Same as above +4"

45" Models

- 4195** 1937-52 45" Solo (Male Head) (67025-37)
- 4197** 1962-73 45" Servi-Car (67028-62)
- 47413** 1937-73 45" Solo with late type 1962-on Speedo head

Tach Cables

- 2539** Fit XL 1974-80, FL 1961-69 with Distributor Drive. Std. (92065-74)
- 4870** 1970-73 Large end XL's only (92065-70)
- 47425** 1962-70 XL (92069-67)

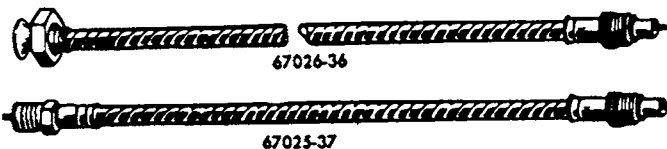

Speedo Cable



Barnett Speedo Cable Assemblies

All SS Barnett cables are clear coated.

Black	SS	Description
47280	47285	40" FWD cable w/16mm top nut fits FX, FXS 73-78, FXR, XLX 83-85, XLH 84-85,
47281	47286	43" FWD cable w/16mm top nut fits XLS 84-85, FXE/FXRT 83-85
47282	47287	47" FWD cable w/16mm top nut fits XLS 1983
47283	47288	40" FWD cable, 12mm top nut fits FLT 80-83 FLTC 80-86, FXR/S 82-83, XL 72-84, FLHT 80-86, FLHTC/P 80-92

Transmission Drive Cables

47295	36" cable w. 5/8-18 top nut fits all FL/FX
47296	46" cable w. 5/8-18 top nut fits all XL 65-69
47299	46" cable w. 16mm top nut fits XL 70-72
47606	Stainless steel cable fits XL 70-72

Barnett Tachometer Cable Assemblies

PCP	Description
47298	32" cable with 16mm top nut fits XL 1970-73
47297	33" cable with 12mm top nut fits XL 1974-80

Cable Adaptor

Allows the use of a 5/8" cable on 12mm threaded speedos.

12631

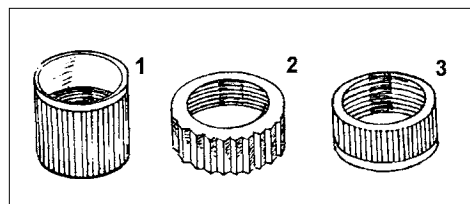
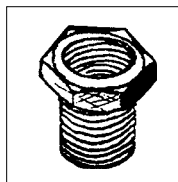

Speedo Cable Nuts

For use with front wheel drive cables. Sold in 5 packs.

#	PCP	Description
1	12620	XL-FXR 12 mm
2	12621	FXE 1973-77, 16mm Fine
3	12622	Fat Bob 16mm Course 5/8" NPT



Speedo Cable Mounting Clip

Zinc mounting clip used to retain the speedo cable when it runs between the transmission and a dash-mounted speedometer. It is secured by the case stud between the cylinders.

9652 1942-84 (67074-57A) (each)



Chrome Cable End Covers

These chrome accessories cover the fitting on speedo, tach and clutch cables. Sold each.

Clutch Cable Cover

44020 Upper, all 1982-on

Speedo/Tach Cable Cover

44024 Upper, 12mm cable nuts

44026 Lower, all front wheel drive speedo cable only

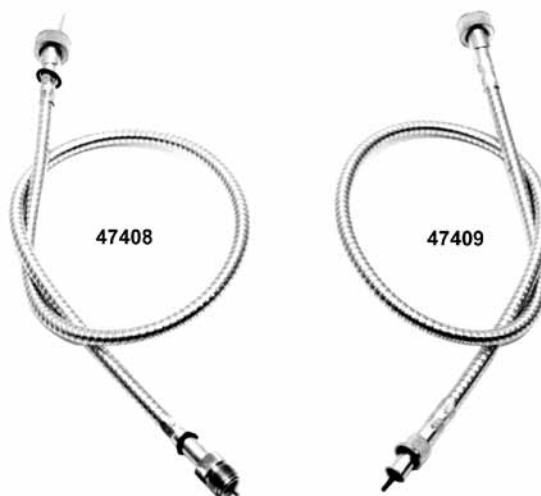

Thick Style FL Cable

This early transmission drive cable with a zinc plated outer steel housing .42" thick, for male & female fittings

47408 Male type for 1936-61 (67026-36A)

47409 Female type for 1962-80, 35.5" long (62026-62)

47416 Female type for 62-80 (black)

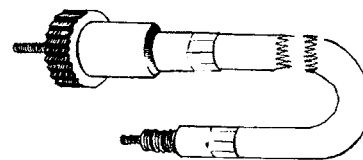

Custom Front Wheel Speedometer Cables

Front wheel drive speedometer cables that allow you to use any of our large FL style dash mounted 2:1 speedometers for front wheel speedo drives. Cable has two speedo head nuts to cover most models. The ideal cable for installation with our FXR Fat Bob tank #6478.

2538 39-1/2" long

47419 As above, stainless

4391 42-1/2" long

47424 As above, stainless